

# NMOA8100 Series Network Managed Optical Amplifier User's Manual

APRIL 2010



**Table of Contents**

**1 INTRODUCTION ..... 5**

**1.1 About this Manual .....5**

**1.2 General Description .....5**

**1.3 Mechanical Dimensions and Operational Conditions .....5**

**1.4 Precautions for Installation and Warnings .....5**

**1.5 Grounding Considerations .....6**

**1.6 Laser Safety .....6**

**2 GETTING STARTED ..... 8**

**2.1 Before Initializing and Operating the Unit .....8**

**2.2 Unpacking .....8**

**2.3 Safety Information .....8**

        2.3.1 Power Requirements ..... 8

**2.4 Safety Instructions .....9**

**2.5 Mounting and Power Connection .....9**

**2.6 Connecting Optical Fiber Patch Cords ..... 11**

**3 PANEL DESCRIPTION .....12**

**3.1 Summary .....12**

**3.2 Panel Description .....12**

        3.2.1 Front Panel ..... 12

        3.2.2 EDFA STATUS LED Information ..... 13

        3.2.3 Rear Panel ..... 15

**4 FRONT PANEL LCD INTERFACE .....16**

**4.1 Summary .....16**

**4.2 LCD Display .....17**

        4.2.1 Menu Selections ..... 17

        4.2.2 Provision Menu ..... 18

        4.2.3 Control Menu ..... 19

        4.2.4 Status Menu ..... 20

        4.2.5 Test Menu ..... 23

        4.2.6 Function Setting Menu ..... 23

        4.2.7 IP Address ..... 24

**5 COMMUNICATION INTERFACE .....25**

**5.1 Command Line Interface (CLI) .....25**

        5.1.1 Connecting to the NMOA8100 Series EDFA through Ethernet port .... 25

        5.1.2 Starting a Telnet Session ..... 25

        5.1.3 ADMIN and USER accounts ..... 27

        5.1.4 Network Configuration ..... 27

        5.1.5 Command Line Interface (CLI) Commands ..... 28

        5.1.6 SNMP Summary ..... 37

**5.2 SNMP MIB Table .....38**

        5.2.1 entPhysicalEntry ..... 38

        5.2.2 propertyEntry ..... 38

        5.2.3 currentAlarmEntry ..... 39



5.2.4	discretePropertyEntry .....	39
5.2.5	alarmsIdent .....	39
5.2.6	commonIdent .....	40
5.2.7	commonMulticastGroup .....	40
5.2.8	heOpticalAmplifierGroup .....	41
5.2.9	heBaselIdent .....	41
5.2.10	hePowerSupply .....	42
5.2.11	heFans .....	42
5.2.12	SNMP Trap Information .....	43
<b>6</b>	<b>PERFORMANCE CHECK.....</b>	<b>43</b>
6.1	Precautions for Testing .....	43
6.2	Measuring Instruments.....	43
6.3	Performance Test Procedure .....	44
6.4	Alarm Test Procedure .....	44
<b>7</b>	<b>TROUBLESHOOTING .....</b>	<b>45</b>
7.1	Troubleshooting Precautions .....	45
7.2	Basic Troubleshooting Procedures.....	45
<b>8</b>	<b>CLAIMS AND REPACKAGING.....</b>	<b>47</b>
8.1	Claims.....	47
8.2	Returning Shipments to Emcore .....	47

### List of Tables

Table 1.	NMOA8100 Series EDFA Inventory .....	8
Table 2.	Laser On/OFF Key Switch .....	12
Table 3.	Control Switch .....	12
Table 4.	LED State .....	13
Table 5.	Control Switch.....	13
Table 6	Provision Menu Descriptions.....	18
Table 7.	Alarm Descriptions .....	22
Table 8	Factory Default Network Configuration .....	27
Table 9	ADMIN and USER Privileges .....	29
Table 10	Factory Default SNMP Settings .....	38
Table 11	entPhysicalEntry .....	38
Table 12	propertyEntry .....	38
Table 13	currentAlarmEntry .....	39
Table 14	discretePropertyEntry.....	39
Table 15	alarmsIdent.....	39
Table 16	commonIdent .....	40
Table 17	commonMulticastGroup.....	40



Table 18 heOpticalAmplifierGroup .....41  
Table 19 heBaselIdent .....41  
Table 20 hePowerSupply .....42  
Table 21 heFans .....42  
Table 22 Instruments for Performance Test .....43  
Table 23 Alarm States and Causes.....46



## 1 INTRODUCTION

### 1.1 About this Manual

This manual consists of eight chapters.

Chapter 1: **INTRODUCTION**  
Chapter 2: **GETTING STARTED**  
Chapter 3: **PANEL DESCRIPTION**  
Chapter 4: **FRONT PANEL LCD**  
Chapter 5: **COMMUNICATION INTERFACE**  
Chapter 6: **PERFORMANCE CHECK**  
Chapter 7: **TROUBLESHOOTING**  
Chapter 8: **CLAIMS AND REPACKAGING**

### 1.2 General Description

The NMOA8100 (Network Managed Optical Amplifier) Series EDFA (Erbium Doped Fiber Amplifier) is a state-of-the-art system that receives optical signals at its input and delivers an amplified optical signal to the output(s). The optical path consists of a length of erbium-doped fiber, which is optically “pumped” with special purpose high power pump lasers. For improved system performance, optical isolators are installed on the input and output of the EDFA. Also, configuration and monitoring of the system is supported with LED indicators, an LCD interface, and electronic communication via an RJ45 Ethernet port. The NMOA8100 Series EDFA supports up to two power supplies configured as AC (110V ~ 220V), DC (-48V) or both.

### 1.3 Mechanical Dimensions and Operational Conditions

- Emcore's NMOA8100 Series EDFA is provided in a standard 19" rack mount, 1U housing.
- Metric dimensions are 432(W) x 375(D) x 44(H) mm.
- The maximum allowed storage temperature range is from -40°C to 85°C.
- The maximum allowed relative humidity range is 10 to 95%.
- The maximum operating temperature range is between 0°C to 50°C.
- The backlit LCD display will operate between -10°C and 60°C.

The electrical power consumption depends on the specific model of the amplifier, and further details can be found in the model specific datasheet.

### 1.4 Precautions for Installation and Warnings

It is important to ensure that there is enough airflow and convection through the upper and lower panels after installation and during operation of the unit.

The NMOA8100 Series EDFA has its own internal circuitry plus an internal

electrical voltage converter. Both will generate heat, and unrestricted airflow is required to ensure proper operating conditions are maintained.

The optical adapters for the EDFA input and output are located on the front or rear panel of the NMOA8100 Series EDFA. When received from the factory the optical adapters will all have caps on them for safety and protection of the fiber end faces. The caps must remain on during the installation of the unit. The installer must keep the optical connection points clean at all times. If the surface of the optical fiber end face is contaminated with dust or dirt, damaged may occur at the optical output as soon as the amplifier activates.

## 1.5 Grounding Considerations

The NMOA8100 Series EDFA includes laser diodes and photo diodes that are extremely sensitive to electrostatic discharge (ESD). When you unpack, install or otherwise handle the EDFA work in an ESD controlled environment and observe ESD precautions including the use of a grounded wrist strap. To avoid performance degradation or even complete loss of functionality, install in a properly grounded equipment rack. The F.G. terminal must be connected to Earth/Ground for protection of the unit during installation and operation. To protect the installation and to prevent unexpected events, such as lightning, static electricity, short circuit, surges, etc., you must use a properly grounded receptacle for the AC power cord.



## 1.6 Laser Safety

FDA/CDRH Class 1M and IEC® 60825 Class 1M laser product.  
All versions are Class 1M laser products per IEC 60825-1:2007 EN 60825-1:2007  
Maximum Output: 30 mW, Wavelength: 1550 nm

**CAUTION: Use of controls, adjustment, and procedures other than those specified here may result in hazardous laser radiation exposure.**



## 2 GETTING STARTED

### 2.1 Before Initializing and Operating the Unit

Check that the units and contents are complete, and no signs of visible damage on any portion of the exterior surface. Read the user manual carefully. Become familiar with all safety symbols and instructions to ensure the EDFA is operated and maintained safely.

### 2.2 Unpacking

Check that the unit and contents are complete:

1. Wear an anti-static wrist strap and work in an electrostatic discharge (ESD) controlled area.
2. Inspect the shipping container for any indication of excessive shock to the contents, and inspect the contents to ensure that the shipment is complete.
3. Inspect the unit for structural damage that may have occurred during shipping.

Note: Keep the packaging to prevent damage to the unit in any future transport of the device.

Immediately inform Emcore and, if necessary, the carrier if the contents of the shipment are incomplete, if the unit or any of its components are damaged or defective, or if the unit does not pass the initial inspection.

Table 1. NMOA8100 Series EDFA Inventory

Item	Quantity
NMOA8100 Series EDFA	1
CD with Instruction Manual	1
TEST REPORT	1
Keys	2
AC Power Cord (if applicable)	1 or 2

**WARNING:** Take all proper grounding precautions when unpacking the product. Notify Emcore immediately if any parts are missing.

### 2.3 Safety Information

#### 2.3.1 Power Requirements

The system will operate from an AC power source that supplies: 85~265V AC,

50~60 Hz; 2A or a DC power source that supplies: -36~-72V DC.

## 2.4 Safety Instructions

The following safety instructions must be observed whenever the unit is operated, serviced, or repaired. Failure to comply with any of these instructions or with any precaution or warning contained in the user's manual is in direct violation of the standards of design, manufacture, and intended use of the unit. Emcore assumes no liability for the customer's failure to comply with any of these safety requirements.

Before Initializing and Operating the Unit

- Inspect the unit for any signs of damage, and read the user's manual thoroughly.
- Install the unit as specified in the **Preparation** section.
- Ensure that the unit and any devices or cords connected to it are properly grounded.

## 2.5 Mounting and Power Connection

1. Mount the unit into a 19-inch wide rack or cabinet.
2. Turn unit power supply switch(es) OFF
3. Insert the key that came with the unit into the key switch on the front panel, and turn the laser key switch OFF
4. For dual AC Models: Plug the two power cords supplied with the unit into the three-prong connectors on the rear panel of the EDFA and plug the other ends of the two power cords into a (85-265V VAC, 50-60 Hz power source (e.g. wall socket)
5. For DC powered models: carefully connect wires DC+, DC-, and GND to the terminal that is connected to the DC input of the power supply. The DC source must be 36-72VDC and wires used must handle 65VA.
6. Turn the unit power switch to the ON position.

**Note:** The EDFA can operate with a single power supply and/or from two different power sources.

If the LCD on the front panel lights up, this indicates that the system electric power supply is working properly.

If the LCD does not light up, double check to see if the cord is plugged in.

If necessary, disconnect all power sources to the unit and check the fuses, located between the power switch and the AC power receptacle, or between the power switch and the DC terminal block depending on the power supply type. See diagrams below:

**AC Electric Power Supply Connection (rear panel)**

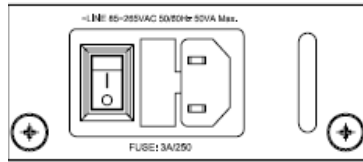

(AC) input voltage range: 85~265V AC, 50~60 Hz

**DC Electric Power Supply Connection (rear panel)**

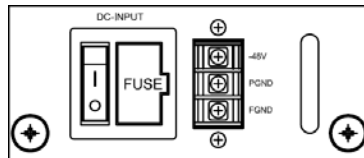

(DC) input voltage range: -36~-72V(for DC-48V)

**DC connector dimensions**

Below is a list of acceptable DC connectors that can be used to establish connections to the terminal blocks of the unit:

● **FORK-TYPE**

- Material : Electrolytic Copper
- Surface : Tin plated
- Insulation : Polyvinyl Chloride

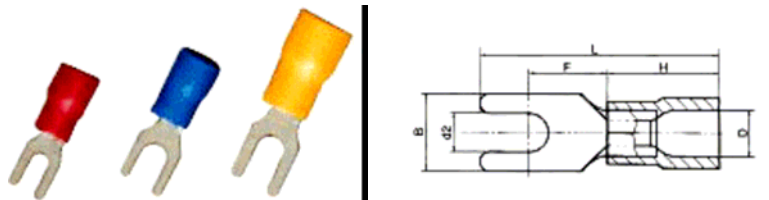

Wire Range		Stud Size	Dimension (mm)						
AWG	mm <sup>2</sup>		d <sub>2</sub>	B	L	F	d <sub>1</sub>	G	T
22~16	1.25	3	3.3	5.9	19.0	4.5	4.2	10.0	0.65

● **RING-TYPE**

- Material : Electrolytic Copper
- Surface : Tin plated
- Insulation : Polyvinyl Chloride

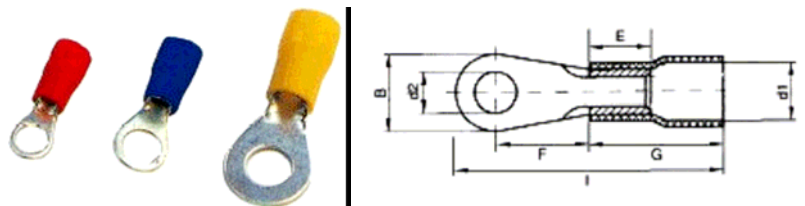

Wire Range		Stud Size	Dimension (mm)							
AWG	mm <sup>2</sup>		d <sub>2</sub>	B	L	F	d <sub>1</sub>	G	E	T
22~16	1.25	3	3.2	5.4	16.3	4.0	4.2	10.0	5.0	0.65

## 2.6 Connecting Optical Fiber Patch Cords

1. Clean all fiber patch cords before connecting to the EDFA.

Cleaning Guidelines:

### Fiber Patch cord connectors

- Remove the fiber connectors dust cap and wipe the fiber connector tip with a dry lint-free cloth (such as Kimwipes®). Inspect for scratches or debris on connector surface by using a microscope (ie.100x or 200x).
- If no scratches or debris are found the connector is now clean and ready for connection. If debris or scratches are found then repeat the fiber patch cord connector cleaning guidelines.

### Fiber Bulkhead connectors

- Compressed air may be used to clean fiber bulkhead connectors. Use compressed air with at least the following specifications:
  - Non-residue, inert gas for precision dust removal
  - Ultra-filtered to < 0.2 microns
  - Recommended for optical systems.
- Using compressed air as listed above, lift or remove the bulkhead dust cover and hold the can of compressed air about 6 inches from the connector. After spraying a few short bursts into the bulkhead the connector is clean and ready for connection.

**CAUTION: Use caution when handling fibers. Do not exceed fiber**

**CAUTION**

**manufacturers pulling tension or bend radius specifications.**

### 3 PANEL DESCRIPTION

#### 3.1 Summary

In this chapter, general information about the front and rear panels of the NMOA8100 Series EDFA is presented. The individual switches and connections will be introduced.

#### 3.2 Panel Description

##### 3.2.1 Front Panel

Below is a typical drawing of an NMOA8100 front panel (in this case a four-port SC/APC unit with front fiber connections), and following a descriptive summary of the components.

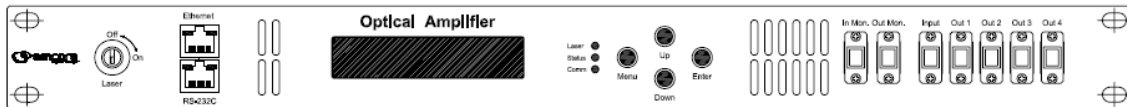

- **Laser ON/OFF key switch**

Table 2. Laser On/OFF Key Switch

Condition	3.2.1.1.1.1 Description
ON	Normal Operation
OFF	Forces the EDFA optical output power to be disabled

- **Communication Terminal Port**

Table 3. Control Switch

Port	Description
Ethernet	Ethernet Communication Port for SNMP Monitor and Control
RS-232C	Serial Communication Port for RS-232C Monitor and Control (factory use).

- **An LCD screen**



- **Three LED's indicating the EDFA's state**

Table 4. LED State

LED	Color	3.2.1.1.1.1.1 Indication
Laser	Green	Pump Lasers On
	Red	Pump Lasers Off
Status	Green	Normal Operation (No Alarm)
	Red	LOS Alarm / LOP Alarm
	Yellow	Bias / Temp / Case Temp/ Power / FAN Alarm
Comm.	Blue	Ethernet Link On

- **Menu control switches for front panel user interface**

Table 5. Control Switch

Switch	3.2.1.1.1.2 Function
MENU	Enters the menu displayed on the LCD, or returns level to the previous menu
ENTER	Applies the current menu item selection
UP/DOWN	Allows user to scroll up and down through the menu items

- **Optical connection ports**

Figure 6. Complete with an input test monitor point, output test monitor port, input and one or more outputs (four shown in this case).

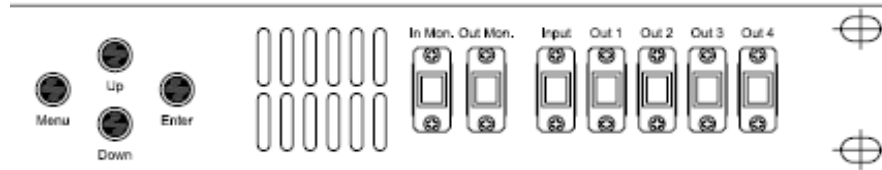

### 3.2.2 EDFA STATUS LED Information

- **LOS (Loss of Signal) Alarm**

When the input optical signal power to the EDFA is lower than the minimum input threshold, the color of status LED changes from green to red (see the TEST REPORT for factory measurement of the threshold. The threshold for triggering the loss of input signal alarm is set below the minimum optical input level).

In the event of a Loss of Signal (LOS) alarm activation, the EDFA will automatically shut down the internal pump lasers, and the optical output power will drop to zero. In response to a loss of input signal, the bias current of the pump laser diode goes into a shutdown (Laser OFF) state to prevent damage to the laser diode.

This condition is automatically reset when the input power is restored to a power above the LOS alarm threshold for the EDFA. The EDFA returns to its normal state, the color of status LED changes from red to green, and the Laser ON state condition returns.

■ **LOP (Loss of Output Power) Alarm**

When the optical output power of the EDFA drops below the reference output power, the color of the status LED changes from green to red. This level is nominally 3dB below the reference output power of the unit, and the actual value at manufacture is recorded in the test report that comes with the unit.

If the Laser OFF state is selected from the LCD menu, the color of the status LED changes from green to red.

The LOP alarm will not be active during normal operation, and if it active, will clear when the output optical power of the EDFA returns to normal. In this case the color of status LED will be green.

■ **BIAS Alarm**

The Pump Laser Diode(s) provides optical energy to the Erbium Doped Fiber in the EDFA. The optical output power of the Pump Laser Diode(s) is a function of the electrical bias current that is applied to the laser. Over the course of the life of an EDFA, the pump lasers are expected to “age”, and slow degradation in energy conversion efficiency from electrical to optical output power occurs. Thus, the pump lasers have a “beginning of life efficiency”, and an “end of life efficiency”. The end of life current is defined as 120% of beginning of life current, and is stored in the unit's non-volatile memory during initial manufacture. In the event the bias current of the pump laser diode exceeds 95% of the end-of-life (EOL) value, the pump bias current alarm will be activated. The pump laser diode driver is limited to never exceed the EOL bias level. If the BIAS alarm is activated, the color of status LED changes from green to yellow.

■ **TEMP Alarm**

The internal temperature of the Pump Laser Diode(s) must be kept within a specified operating range. The the temperature of the Pump Laser Diode(s) is continuously monitored with the use of a thermocouple. If the internal temperature of the Pump Laser Diode is found to be outside of the operational range, the TEMP alarm will be activated.

If the TEMP alarm signal is activated, the color of status LED will change from green to yellow.

■ **POWER Alarm**

The voltage of power supply must be kept within a specified operating range. The internal power supplies are continuously monitored with sensing electronics, and in the event that the voltage of a power supply is found to be outside of the operational range, the POWER alarm will be activated.

If the POWER alarm signal is activated, the color of status LED will change from green to yellow.

■ **FAN Alarm**

Both fans must be kept operating. If one or more fans are not operating, the FAN alarm is activated.

If the FAN alarm signal is activated, the color of status LED will change from green to yellow.

**3.2.3 Rear Panel**

The rear panel of the NMOA8100 Series EDFA consists of two hot swappable power modules and two fans, and a chassis ground lug.

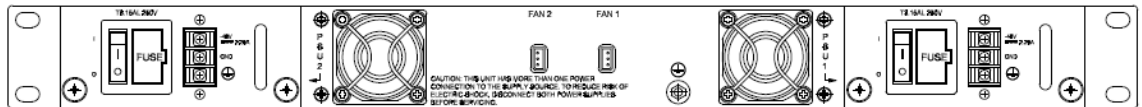

(DC)

(DC) input voltage range: -36~-72V(for DC-48V)

OR

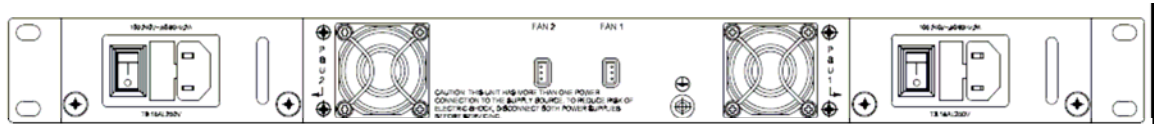

(AC)

(AC) input voltage range: 85~265V AC, 50~60 Hz

## 4 FRONT PANEL LCD INTERFACE

### 4.1 Summary

In this chapter, an overview of the operation of the EDFA using the front panel user interface is explained. The diagram below represents a block diagram description the operational menu tree accessible through the LCD display.

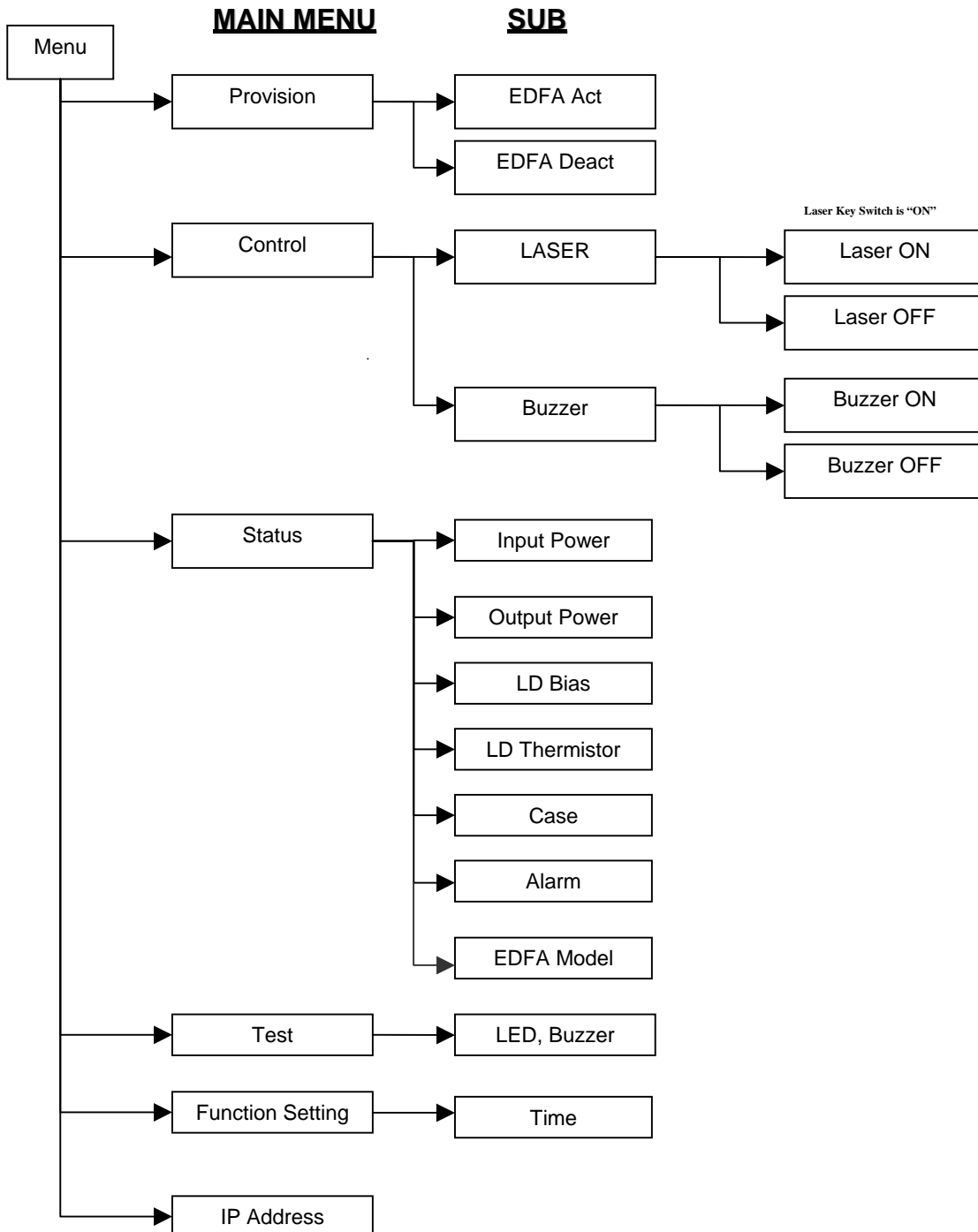

## 4.2 LCD Display

When the unit is first powered ON, the LCD display will initially report the following:

**Optical Amplifier**  
1.1.1.1.

**NOTE:** In all LCD menus, if you do not select a menu button for about 15 seconds, the menu will automatically return to the previous or default menu state.

### 4.2.1 Menu Selections

The main menu categories are: Provision, Control, Status, Test, Function Setting and IP Address. You can select any of these categories by first selecting the Menu button, and then using the Up/Down buttons to scroll through the list of available options.

For example, from the initial start-up, press the Menu button once.

The LCD display will change to display the first two main menu options, with the cursor (indicated by ">" symbol) is active on the "Provision" menu.

**>Provision**  
Control

With one push of the Down button, the cursor will move to the "Control" menu option.

Provision  
**>Control**

Another push of the Down button, will call up the next two menu items, Status and Test, with the cursor now on Status.

**>Status**  
Test

Another push of the Down button will move the cursor to the Test menu.

Status  
**>Test**

The final two menu items (Function Setting and IP Address) will now be displayed.

**>Function Setting**  
IP Address

IP Address is the last main menu available to select.

From the above screen if you push the Down button two more times, the first two main menu items will reappear, and so on. It is possible to reverse through the list with the Up button at any time.



**4.2.2 Provision Menu**

A user is able to control the operational state of the EDFA by selecting the Provision menu option. There are two operational states to choose from: active (ACT) and deactivate (DEACT). Select ACT for normal operation, and DEACT for normal operation with alarm information suppressed. The table below summarized the differences.

Table 6 Provision Menu Descriptions

ACT State	DEACT State
EDFA: normal operation	EDFA: normal operation Status LED: GREEN (Alarm information is not detected)

■ **Provision menu operation**

Select the Provision menu by pressing the Enter button when the cursor is pointing at Provision.



The Provision sub menu will now be displayed.



The first line of the above screen indicates the current state of the EDFA. If you want to change the current state, move the cursor with the Up or Down button to the setting you wish to select, and push the enter button



The LCD screen will display the action momentarily, and return to the previous Main menu.



### 4.2.3 Control Menu

In the Control Menu, a user is able to modify the state of the EDFA output by setting the Laser to ON or OFF. Also one can enable or disable the audible Buzzer alarm from this menu.

For Example, from the main menu, move the cursor to the Control menu item.



Push the Enter button to advance to the Laser menu.

#### ■ Laser ON/OFF



As illustrated in the example screen below, the first line indicates the current state of the EDFA laser (in this case OFF). If a user wants to select a different state, the Up or Down button will toggle between the two options. Press enter to select the desired state.



Note if the Laser key switch is in the OFF State, selecting Laser Setting ON will have no effect. If the EDFA and Key switch is currently ON, and unit is in normal operation, selecting OFF will disable the optical output power from the unit, and the Laser LED will turn Red.



■ **Buzzer ON/OFF**

If the unit is in normal operation, the alarms are enabled (Provision = ACT), and the Buzzer setting is ON, an alarm condition on the EDFA will result in an audible Buzzer sound. If and when the alarm condition of the EDFA is removed, the Buzzer sound will automatically stop.



As illustrated in the example screen below, the first line indicates the current selected buzzer state of the EDFA.

If a user wants to select a different state, the Up or Down button will move the cursor to the desired state, and Enter will select it.



For example, pushing the Enter button from the above example will result in a momentary information screen similar to below before returning to the main menu.



When the Buzzer selection is OFF and an EDFA alarm is activated, the Buzzer sound will not activate. Also, if the unit alarms are disabled (Provision = Deact), the buzzer will not activate under an alarm condition whether the Buzzer state is ON or OFF.

**4.2.4 Status Menu**

The Status menu allows a user to conveniently monitor the operational state and key parameters of the EDFA and it's components.



The first sub menu item is **Input Power**. The Input Power is the optical input power as measured by the internal photo-detector that is constantly monitoring this parameter.

>Input Power  
Output Power

Input Power will be displayed in dBm.

Input Power  
XX.XX dBm

The next sub menu item is **Output Power**. The Output Power is the optical output power as measured by the internal photo-detector that is constantly monitoring this parameter. If the EDFA has multiple output ports, all ports will be available to view with values displayed in dBm.

Input Power  
>Output Power

Output Power 1  
+XX.XX dBm

Output Power x  
+XX.XX dBm

The **LD Bias Current** is the measured bias current being applied to the pump laser diode.

>LD Bias Current  
LD Thermistor

For units with multiple pump lasers, all bias currents will be available in the menu, and indicated as LD1, LD2 etc. The LD Bias Current(s) will be display in mA.

LD Bias Current  
LD1 : XXXX mA

The **LD Thermistor** menu item reports the temperature of the individual pump laser diodes in Celsius (°C).

LD Bias Current  
>LD Thermistor

LD Thermistor  
LD1 : XX °C

Selecting the **Temperature** menu item will report the EDFA module temperature in Celsius (°C).

Temperature  
XX °C

The **Alarm Status** menu allows for a check of the unit's Alarm status.

Temperature  
> Alarm Status

To move another alarm state, push Up/Down button.

CaseTemp : OK  
IPM : OK

IPM : OK  
OPM : OK

...

LD1 Ther : OK  
CaseTemp : OK

Table 7. Alarm Descriptions

Name	Variable	Description
CaseTemp.	Case Temperature	■ Temperature state of the EDFA module. (OK: Normal, FAIL: Abnormal)
IPM	Input Power	■ Input optical signal power to the EDFA. (OK: Normal, FAIL: Abnormal)
OPM	Output Power	■ Output optical power of the EDFA. (OK: Normal, FAIL: Abnormal)
POWER 1	Power Supply 1	■ Power Supply state of the EDFA module. (OK: Normal, FAIL: Abnormal)
POWER 2	Power Supply 2	■ Shows the Power Supply state of the EDFA module. (OK: Normal, FAIL: Abnormal)

<b>FAN 1</b>	Fan1	■ Shows the FAN state of the EDFA module
<b>FAN 2</b>	Fan2	■ Shows the FAN state of the EDFA module (OK: Normal, FAIL: Abnormal)
<b>LD1 BIAS</b>	Current	■ Shows the state of the Pump Laser Diode Bias current. (OK: Normal, FAIL: Abnormal)
<b>LD1 THER</b>	Thermistor	■ Shows the temperature state of the Pump Laser Diode. (OK: Normal, FAIL: Abnormal)

Selecting EDFA Model Name will provide the full model string of the unit.

**>EDFA Model Name  
Input Power**

**>EDFA Model Name  
NMOA8100-2201-1003**

#### 4.2.5 Test Menu

The Test menu allows a user to perform simple tests on the LEDs and Buzzer to ensure they are functioning correctly.

**Status  
>Test**

Select LED Test to see the Laser and Status momentarily turn yellow and flash.

**>LED Test  
Buzzer Test**

Select Buzzer Test to hear a momentary audible chirp.

**LED Test  
>Buzzer Test**

#### 4.2.6 Function Setting Menu

It is possible to set the real time clock of the system from the front panel by selecting the Time menu item.

**>Time**

A user may select the Time menu item followed by Present Time to see the present date and time of the unit:

**>Present Time  
Setting Time**

The Time will be displayed similar to below example.

**YYYY MM DD HH MM SS  
2014/06/09 15:05:30**

The Setting Time sub menu will allow a change to the date and time.

**Present Time  
>Setting Time**

A push of the Down button will move the cursor one position to the right, and a push of the up button will cause an increment to the value selected.

**YYYY MM DD HH MM SS  
2014/06/09 15:05:30**

**YYYY MM DD HH MM SS  
2015/06/09 15:05:30**

**YYYY MM DD HH MM SS  
2015/06/09 15:05:30**

Pressing the enter button, will store the new time value.

#### 4.2.7 IP Address

The IP Address menu will report the current IP address setting for the Ethernet interface.

**IP Address :  
123.456.0.789**

## 5 COMMUNICATION INTERFACE

### 5.1 Command Line Interface (CLI)

A user can monitor or control the EDFA remotely with the Console via the Ethernet port.

#### 5.1.1 Connecting to the NMOA8100 Series EDFA through Ethernet port

With the EDFA power off, connect a RJ-45 cable between a personal computer and the NMOA8100 Series EDFA Ethernet port on the front. Power up the NMOA8100 Series EDFA optical amplifier. Invoke a terminal emulation program on the PC (in this example invoking a DOS prompt on a PC with Windows XP installed, by selecting start -> Run..., and then typing "cmd" at the prompt.)

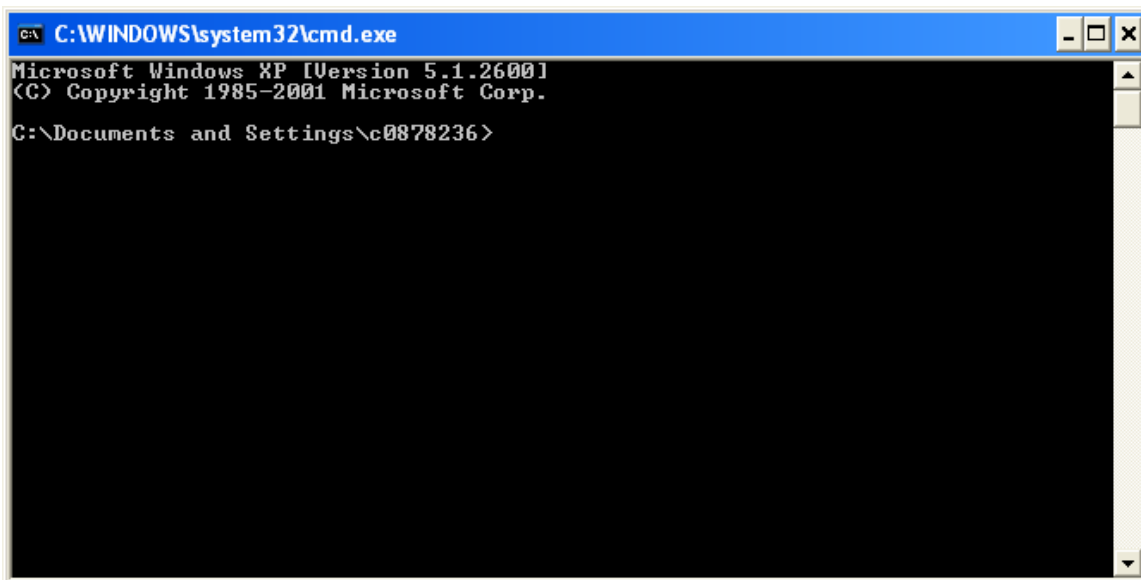
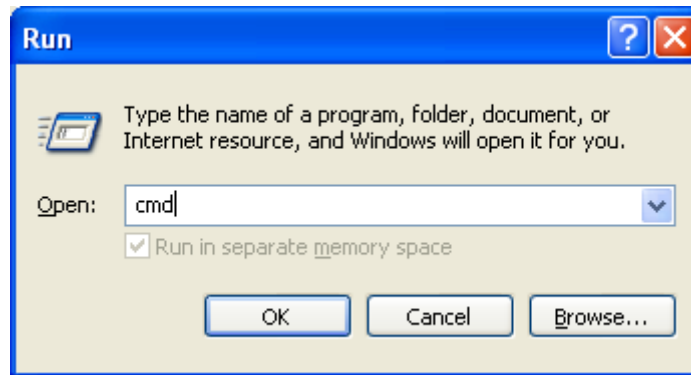

#### 5.1.2 Starting a Telnet Session

Check the IP address of the EDFA by using the menu item IP Address in the front panel (section 4.2.7)

It may be necessary to configure the network connection parameters on the PC to make a connection. For example it may be necessary to configure your PC's LAN connection to have the first three octets of the PC's IP address setting consistent with the first three octets of the NMOA8100 IP Address.

For example, if the NMOA8100 unit IP address is set to the default 192.168.0.100, from the PC, if using Windows XP operating system, select:  
Start -> Control Panel -> Network Connections -> Internet Protocol -> TCP/IP ->  
Use the following IP address: 192.168.0.101 -> subnet mask: 255.255.255.0

Consult your IT department for further assistance if required.

A proper connection will be established when a "ping" command results in successful packet return (see below window)

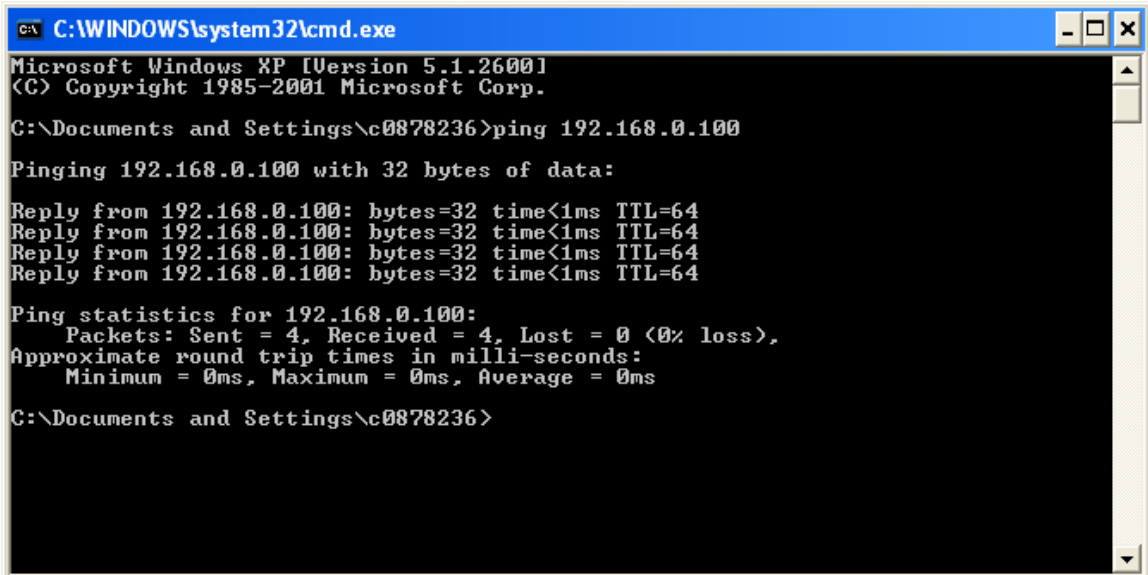

```
C:\WINDOWS\system32\cmd.exe
Microsoft Windows XP [Version 5.1.2600]
(C) Copyright 1985-2001 Microsoft Corp.

C:\Documents and Settings\c0878236>ping 192.168.0.100

Pinging 192.168.0.100 with 32 bytes of data:

Reply from 192.168.0.100: bytes=32 time<1ms TTL=64
Reply from 192.168.0.100: bytes=32 time<1ms TTL=64
Reply from 192.168.0.100: bytes=32 time<1ms TTL=64
Reply from 192.168.0.100: bytes=32 time<1ms TTL=64

Ping statistics for 192.168.0.100:
    Packets: Sent = 4, Received = 4, Lost = 0 (0% loss),
    Approximate round trip times in milli-seconds:
        Minimum = 0ms, Maximum = 0ms, Average = 0ms

C:\Documents and Settings\c0878236>
```

At the command prompt, type the following case sensitive command (replacing the IP Address with the one found in the LCD display):

```
telnet 192.168.0.100
```

A script will run, and user will see something similar to the screen shot below in the Console window. And a prompt for Login will appear.

```

telnet 192.168.0.101
*****
* Optical Amplifier Shelf System                               *
*                                                              *
*                               SNMP Board ver 1.3             *
* S/W ver : 01.02.00.00      Update : Aug 6 2008            *
*****
Login : admin
Password : admin
ADMIN:>
    
```

### 5.1.3 ADMIN and USER accounts

ADMIN and USER accounts are established separately for different access priorities. ADMIN account holder can set passwords for both ADMIN and USER accounts. The default unit user id is “admin” and password is “admin”. Administrative work, such as network connection settings, monitor and control of the EDFA are allowed under the ADMIN account.

The USER account holder, for example the equipment operator, will have permission to monitor the EDFA’s status, but will not have permission to change passwords or settings. The default unit user id is “user” and password is “user”.

### 5.1.4 Network Configuration

The user will need to set up network configuration for the product, which can be accomplished within the Console.

The factory default IP address is 192.168.0.100. The network configuration can be modified by either SNMP or Telnet. Once modified, the unit will need to be rebooted in order for the new configuration to be stored. The reset command within the CLI performs the function.

Note that the network configuration can be set only from within the ADMIN account.

Table 8 Factory Default Network Configuration

Item	Default Value
IP	192.168.0.100
SubnetMask	255.255.255.0
Gateway	192.168.0.1

The CLI commands required to make changes are **ip**, **subnetmask**, **gateway** and **reset**. Details for the commands and their arguments are described in section 5.1.5. Follow the example below on how to change these settings:

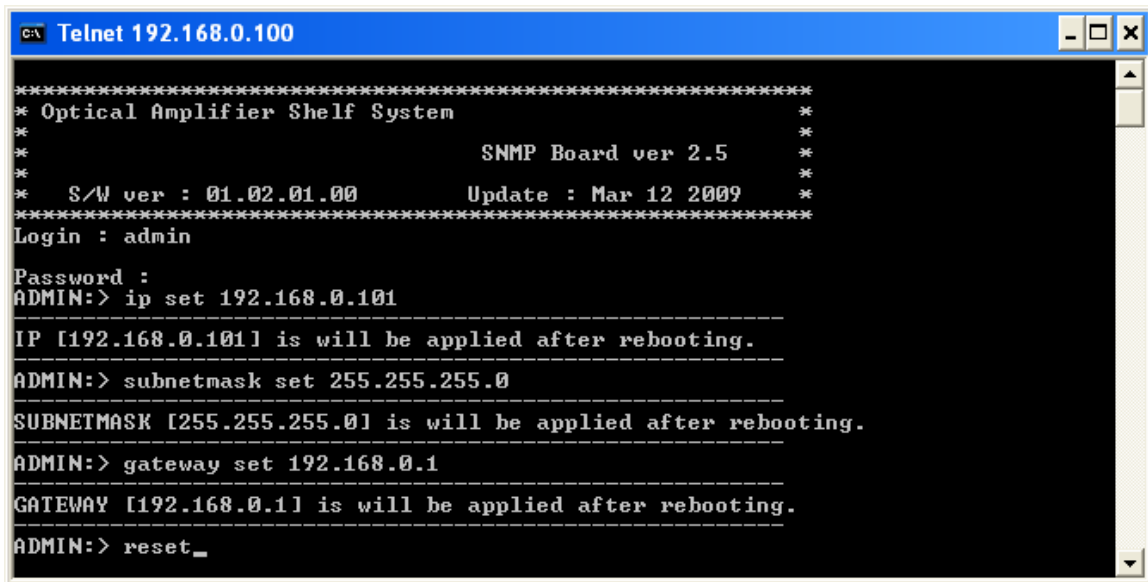

```

c:\ Telnet 192.168.0.100
*****
* Optical Amplifier Shelf System *
* *
* SNMP Board ver 2.5 *
* *
* S/W ver : 01.02.01.00 Update : Mar 12 2009 *
*****
Login : admin
Password :
ADMIN:> ip set 192.168.0.101
-----
IP [192.168.0.101] is will be applied after rebooting.
-----
ADMIN:> subnetmask set 255.255.255.0
-----
SUBNETMASK [255.255.255.0] is will be applied after rebooting.
-----
ADMIN:> gateway set 192.168.0.1
-----
GATEWAY [192.168.0.1] is will be applied after rebooting.
-----
ADMIN:> reset_

```

Since the IP address has changed after the reset, the user will need to invoke a new Telnet sessions to continue with other CLI functions.

### 5.1.5 Command Line Interface (CLI) Commands

**Note:** the syntax information of a CLI command will be provided if a user enters the Command without any arguments.

#### Summary:

**?** : Displays summary list of available Commands in the CLI with a brief description for convenience.

**ver:** Displays hardware and SW version information about the EDFA.

**cls:** Clears the console screen.

**ping:** Sends IP packets and reports response to confirm proper network connection.

**logout** : Performs a log out from ADMIN or USER account. Note, a logout will not end the Telnet connection, and user can log back in from the prompt.

**ip:** Allows users to get or set the unit's IP address.

**subnetmask:** Allows user to get or set the subnetmask information for the

unit.

**gateway:** Allows user to get or set the subnetmask information for the unit.

**initsys:** This command will initialize the product to the factory default configuration. All configurations including log information will be initialized.

**reset:** Resets the network interface settings due to network reconfiguration steps. Operation of optical amplifier is not affected by this command, however communication may need to be reestablished via the Ethernet port.

**mpu :** Command to access the Main Process Unit configuration and allows settings such as time and buzzer configuration

**ofau :** OFAU (Optical Fiber Amplifier Unit) command provides access to status and setup of the optical amplifier module resident within the system.

**snmp :** Command for SNMP configuration and confirmation.

**log :** Check log information and clear the log. Log information can only be cleared through the command line interface.

**timesync :** Command to manually update the RTC (Real Time Clock).

Table 9 ADMIN and USER Privileges

Command Execution Privileges		
command	ADMIN	USER
ver	O	O
cls	O	O
ping	O	O
logout	O	O
ip	Read/Write	Read Only
subnetmask	Read/Write	Read Only
gateway	Read/Write	Read Only
initsys	O	X
reset	O	O
mpu	Read/Write	Read Only
otu	Read/Write	Read Only
ofau	Read/Write	Read Only
snmp	Read/Write	Read Only
log	Read/Write	Read Only
timesync	O	X

**Details:**

**5.1.5.1 VER**

Software and SNMP board version information. (example below)

```
[ADMIN]# VER
*****
* Optical Amplifier Shelf System *
*                               *
*           SNMP Board ver 1.3   *
*                               *
* S/W ver : 01.00.00.00   Update : Jun 18 2008 *
*****
```

**5.1.5.2 CLS**

Clears the console screen.

**5.1.5.3 PING**

Confirms IP address is correctly connected to the physical device. (example below)

```
[ADMIN]# PING 192.168.0.1
192.168.0.1 is alive.
```

**5.1.5.4 LOGOUT**

Log out from the Console. Telnet session will remain established.

**5.1.5.5 IP**

View or set up IP Address. Allows all units in network to have a unique IP address.

**5.1.5.6 SUBNETMASK**

View or set up SubnetMask Address. Check network connection configuration before set up.

**5.1.5.7 GATEWAY**

View or set up Gateway Address. Confirm Gateway address of connected network before set up.

**5.1.5.8 INITSYS**

Initialize the product with factory default setup. Note that all the configurations, including log information, will be initialized.

**5.1.5.9 RESET**

Reset network connections for configuration change or connection reset. The OFAU (Optical Fiber Amplifier Unit) operation is not affected by this command. Only the network connection will be reset.

**5.1.5.10 MPU**

Allows user to check the MPU information and status of physical devices connected the MPU. In addition, a basic set up of the MPU is possible. See below for examples.

```
Usage : MPU [ARG1] [ARG2] [ARG3]
ARG1 : GET, SET
```



```

ARG2 : GET - SYSINFO. MPU module Information
      STATUS. MPU module Status
      CONFIG. MPU module Configuration
      INPOWER. Input Power Value of MPU Module
      SET - TIME.
      DESCR. MPU Description
      ALS. Machine All ALS Control
      BUZZ. MPU Buzzer Setting
ARG3 : TIME - Set New Time. [YYYYMMDDhhmmss]
      DESCR - Enter User define string.[Len:0 ~ 20]
      ALS - ON, OFF
      BUZZ - ON, OFF
    
```

MPU SET DESCR [Len : 0 ~20]: Input MPU Description  
 (Ex) MPU SET DESCR Shelf-OFA for Node 1

MPU SET TIME [YYYYMMDDhhmmss] : Input time information for the MPU. Use 14 digits to input the time information in the following format: [YYYYMMDDhhmmss].  
 (Ex) MPU SET TIME 20061207091830

MPU GET SYSINFO : View MPU Model Name, Description, Serial Number, Firmware Version, Hardware Version. (Ex)

```

[ADMIN]# MPU GET SYSINFO
-----
Model Name : XXX
Description : EMCORE
Serial Number : XXX
Firmware Version : 1.00
Hardware Version : 1.00
-----
    
```

MPU GET\_STATUS : View MPU time information. (Ex)

```

[ADMIN]# MPU GET STATUS
-----
Current Time (Bit) : 2006/12/07 11:48:34
Provision (Bit) : 0x1
Card ACT (Bit) : 0x1
Card Alarm (Bit) : 0x0
-----
    
```

### 5.1.5.11 SHELF (Highest System Level Information)

Provides Basic information of the EDFA at the system level. (Ex)

```

Usage : SHELF [ARG1] [ARG2] [ARG3] [ARG4]
ARG1 : GET, SET
ARG2 : GET - INFO - SHELF system information
      PSINFO - Power Supply Output Power
      ALARM - Now, all alarm value of shelf system
      SYSTH - Alarm threshold value of shelf system
      LOG - System log information
    
```

SET - PSEN - Power Supply Alarm Enable/Disable  
 AGR3 : INDEX (1 ~ 2)  
 AGR4 : VALUE (1 : alarm enable, 0 : alarm disable)

SHELF GET INFO : View Logical ID

SHELF GET PSINFO : Power supply module information. (Ex)

# Power Supply Voltage Information.

Power supply module count : [2]

Power supply No.[1] type : AC 220V

PS output voltage : [50]

Alarm enable value : [1]

Power supply No.[2] type : DC -48V

PS output voltage : [55]

Alarm enable value : [0]

Divide value by '10'

SHELF GET ALARM : All alarm status of at the system  
 '1' value indicates clear. Any other value indicates an alarm state.

(Ex)

# Now, All alarm value of SHELF system. #

\* FAN status alarm \*

No.1 : [1]

No.2 : [1]

Value '1' is OK. Value '6' is FAIL.

\* Power supply status alarm \*

No.1 : [1]

No.2 : [1]

Value '1' is OK. Another Value is FAIL.

\* Casetemp status alarm : [1].

Value '1' is OK. Another Value is FAIL.

\* Optical component status alarm \*

IPM status alarm : [1]

OPM status alarm : [1]

\* LD component status alarm \*

LD No.1

BIAS alarm : [1]

TEMP alarm : [1]

LD No.2

BIAS alarm : [1]

TEMP alarm : [1]

LD No.3

BIAS alarm : [5]

TEMP alarm : [5]

LD No.4

BIAS alarm : [1]

TEMP alarm : [1]

SHELF GET SYSTH : Indicates the alarm threshold value settings at the system level. (Ex)

```
# SHELF system threshold value

Casetemp alarm threshold value information.
AlarmHIHI : [111]
AlarmHI   : [222]
AlarmLO   : [333]
AlarmLOLO : [444]

Output voltage information of Power Supply No.1.
AlarmHIHI : [555]
AlarmHI   : [666]
AlarmLO   : [777]
AlarmLOLO : [888]

Output voltage information of Power Supply No.2.
AlarmHIHI : [999]
AlarmHI   : [123]
AlarmLO   : [456]
AlarmLOLO : [789]

Divide value by '10'
```

SHELF GET LOG : log information. Max log count : 100, max log index : 32767. (Ex)

```
# Log Count : [14] (1 ~ 100)
# Last log index : [14] (1 ~ 32767)

index [1] : [4858e6f9:05:00:06122b06010401ab57010b010301010301030300:02013b] : LD3 BIAS alarm is
occured
index [2] : [4858e6f9:05:00:06122b06010401ab57010b010301010301020300:02011a] : LD3 Temp alarm is
occured
index [3] : [4858e907:05:00:06122b06010401ab57010b010301010301030300:02013b] : LD3 BIAS alarm is
occured
index [4] : [4858e907:05:00:06122b06010401ab57010b010301010301020300:02011a] : LD3 Temp alarm
is occurred
index [5] : [4858ea1b:05:00:06122b06010401ab57010b010301010301030300:02013b] : LD3 BIAS alarm is
occured
index [6] : [4858ea1c:05:00:06122b06010401ab57010b010301010301020300:02011a] : LD3 Temp alarm
is occurred
index [7] : [4858fd84:05:00:06122b06010401ab57010b010301010301030300:02013a] : LD3 BIAS alarm is
occured
index [8] : [4858fd84:05:00:06122b06010401ab57010b010301010301020300:02011a] : LD3 Temp alarm is
occured
index [9] : [4858fdbf:05:00:06122b06010401ab57010b010301010301030300:02013b] : LD3 BIAS alarm is
occured
index [10] : [4858fdbf:05:00:06122b06010401ab57010b010301010301020300:02011a] : LD3 Temp alarm
is occurred
```

```
index [11] : [4858feb8:05:00:06122b06010401ab57010b010301010301030300:02013b] : LD3 BIAS alarm
is occurred
index [12] : [4858feb8:05:00:06122b06010401ab57010b010301010301020300:02011a] : LD3 Temp alarm
is occurred
index [13] : [485928af:05:00:06122b06010401ab57010b010301010301030300:02013e] : LD3 BIAS alarm
is occurred
index [14] : [485928af:05:00:06122b06010401ab57010b010301010301020300:02011a] : LD3 Temp alarm
is occurred
```

**SHELF SET LOG: log information clear. (Ex)**

```
-----
[ADMIN]# shelf set log
-----
[ADMIN]# shelf get log
-----
# Log Count : [0] (1 ~ 100)
# Last log index : [0] (1 ~ 32767)
-----
```

**5.1.5.12 OFAU (Optical Fiber Amplifier Unit) – amplifier module resident in the system)**

Check information on OFAU and its status. In addition, basic set up of OFAU is possible. See below for examples. (Ex)

```
Usage : OFAU [ARG1] [ARG2] [ARG3]
ARG1 : GET, SET
ARG2 : GET - SYSINFO. OFAU Model Information.
        STATUS. OFAU Module Status.
        CONFIG. OFAU Module Config Data.
        OPMODE. OFAU Operation Mode.
ARG3 : Slot Number Value. [1 ~ 10].
        0 - All Slot Information. (Only use GET)
ARG4 : SET - Value [Unit : 0.1 dBm]
        OPMODE Value [20:AGC or 30:APC].
```

**OFAU GET SYSINFO – View OFAU module basic Information. (Ex)**

```
[ADMIN]# OFAU GET SYSINFO
-----
OFAU Slot Number [0]
Model Name : XXX
Description : EMCORE
Serial Number : XXX
Firmware Version : 1.00
Hardware Version : 1.00
-----
```

**OFAU GET STATUS – View OFAU current status. (Ex)**

```
[ADMIN]# OFAU GET STATUS
-----
OFAU Slot Number [1]

EDFA Alarm Status (Bit) : 0x0
Operation Mode : 30
Case Temp. : 32 [°C]
OFA input +5V : 5.1 [V]
```

```

Input Power : XX.XX [dBm]

Number of Optical Output Port : [16]
Output Power of port No.1 : XX.XX [dBm]
Output Power of port No.2 : XX.XX [dBm]
Output Power of port No.3 : XX.XX [dBm]
Output Power of port No.4 : XX.XX [dBm]
Output Power of port No.5 : XX.XX [dBm]
Output Power of port No.6 : XX.XX [dBm]
Output Power of port No.7 : XX.XX [dBm]
Output Power of port No.8 : XX.XX [dBm]
Output Power of port No.9 : XX.XX [dBm]
Output Power of port No.10 : XX.XX [dBm]
Output Power of port No.11 : XX.XX [dBm]
Output Power of port No.12 : XX.XX [dBm]
Output Power of port No.13 : XX.XX [dBm]
Output Power of port No.14 : XX.XX [dBm]
Output Power of port No.15 : XX.XX [dBm]
Output Power of port No.16 : XX.XX [dBm]
    
```

```

Laser Alarm Status (Bit) : 0x0
LD[1] ==> Bias : 0 [mA] Temp. : 21 [°C]
LD[2] ==> Bias : 1 [mA] Temp. : 25 [°C]
LD[3] ==> Bias : 58 [mA] Temp. : 26 [°C]
LD[4] ==> Bias : 48 [mA] Temp. : 25 [°C]
    
```

OFAU GET CONFIG – View OFAU configuration. (Ex)

```

[ADMIN]# OFAU GET CONFIG
-----
OFAU Slot Number [1]

OFA input +5V Low Limit : 4.7 [V]
OFA input +5V High Limit : 5.3 [V]

Input Power Minimum : -15.9 [dBm]
Input Power Maximum : 6.9 [dBm]
Output Power Minimum : -5.0 [dBm]
Output Power Maximum : 18.1 [dBm]

Alarm Level of Input Power : -60.0 [dBm]
Reference Output Power : -60.0 [dBm]

IPM alarm threshold value information.
ALARM HIHI : 11.1 [dBm]
ALARM HI : 22.2 [dBm]
ALARM LO : 33.3 [dBm]
ALARM LOLO : 44.4 [dBm]

OPM alarm threshold value information.
ALARM HIHI : 55.5 [dBm]
ALARM HI : 66.6 [dBm]
ALARM LO : 77.7 [dBm]
ALARM LOLO : 88.8 [dBm]

BIAS and TEMP alarm threshold value information of LD.
# LD NO.[1]
BIAS ALARM HIHI : 111 [mA], TEMP ALARM HIHI : 22.2 [°C]
BIAS ALARM HI : 112 [mA], TEMP ALARM HI : 22.3 [°C]
BIAS ALARM LO : 113 [mA], TEMP ALARM LO : 22.4 [°C]
BIAS ALARM LOLO : 114 [mA], TEMP ALARM LOLO : 22.5 [°C]
# LD NO.[2]
BIAS ALARM HIHI : 333 [mA], TEMP ALARM HIHI : 44.4 [°C]
    
```

```

BIAS ALARM HI : 334 [mA], TEMP ALARM HI : 44.5 [C]
BIAS ALARM LO : 335 [mA], TEMP ALARM LO : 44.6 [C]
BIAS ALARM LOLO : 336 [mA], TEMP ALARM LOLO : 44.7 [C]
# LD NO.[3]
BIAS ALARM HIHI : 555 [mA], TEMP ALARM HIHI : 66.6 [C]
BIAS ALARM HI : 556 [mA], TEMP ALARM HI : 66.7 [C]
BIAS ALARM LO : 557 [mA], TEMP ALARM LO : 66.8 [C]
BIAS ALARM LOLO : 558 [mA], TEMP ALARM LOLO : 66.9 [C]
# LD NO.[4]
BIAS ALARM HIHI : 0 [mA], TEMP ALARM HIHI : 0.0 [C]
BIAS ALARM HI : 0 [mA], TEMP ALARM HI : 0.0 [C]
BIAS ALARM LO : 0 [mA], TEMP ALARM LO : 0.0 [C]
BIAS ALARM LOLO : 0 [mA], TEMP ALARM LOLO : 0.0 [C]-----
-----
    
```

### 5.1.5.13 SNMP Setup Commands

Before attempting an SNMP interface connection, use the SNMP CLI command to setup the Read Only and Read/Write community strings and define the trap IP addresses, community and state (enabled or disabled). See below for examples. (Ex)

```

Usage : SNMP [ARG0] [ARG1] [ARG2] [ARG3]
ARG0 : TRAP , ROCOMM, RWCOMM, TRAPEN, TRAPCOMM
ARG1 : GET , SET
ARG2 : GET - TRAP : Trap Receiver Index. (0 ~ 4)
        - ROCOMM: Read Only Community. Max StrLen 10
        - RWCOMM: Read Write Community. Max StrLen 10
        - TRAPEN: Trap Receiver Index. (0 ~ 4)
        - TRAPCOMM: Trap Receiver Index. (0 ~ 4)
        SET - TRAP: Trap Receiver Index. (0 ~ 4)
        - ROCOMM: Read Only Community. Max StrLen 10
        - RWCOMM: Read Write Community. Max StrLen 10
        - TRAPEN: Trap Receiver Index. (0 ~ 4)
        - TRAPCOMM: Trap Receiver Index. (0 ~ 4)
ARG3 : SET - TRAP : Manager IP. [XXX.XXX.XXX.XXX]
        - TRAPEN: ON, OFF
        - TRAPCOMM: Community Public. Max StrLen 10
    
```

#### SNMP GET TRAP [Index]. (Ex)

```

[ADMIN]# SNMP GET TRAP 1
SNMP Trap Receiver [1] IP : 192.168.0.52
    
```

#### SNMP GET ROCOMM. (Ex)

```

[ADMIN]# SNMP GET ROCOMM
SNMP Read Only Community: public
    
```

#### SNMP GET RWCOMM. (Ex)

```

[ADMIN]# SNMP GET RWCOMM
SNMP Read Write Community: PRIVATE
    
```

#### SNMP GET TRAPEN [Index] (Ex)

```

[ADMIN]# SNMP GET TRAPEN 1
SNMP Trap Receiver- [1] State: OFF [0]
    
```

#### SNMP GET TRAPCOMM [Index] (Ex)

```

[ADMIN]# SNMP GET TRAPCOMM 1
SNMP Trap Receiver- [1] Trap Community: public
    
```

**SNMP SET ROCOMM [string] (Ex)**

```
[ADMIN]# SNMP SET ROCOMM PUBLIC
SNMP Community public: PUBLIC setting success.
This setting will be applied after reboot.
```

**SNMP SET RWCOMM [string] (Ex)**

```
[ADMIN]# SNMP SET RWCOMM PUBLIC
SNMP Community public: PRIVATE setting success.
This setting will be applied after reboot.
```

**SNMP SET TRAPEN [Index] [ON/OFF] (Ex)**

```
[ADMIN]# SNMP SET TRAPEN 1 ON
SNMP Trap [1] Enable Setting Successful...
```

**SNMP SET TRAPCOMM [Index] [string] (Ex)**

```
[ADMIN]# SNMP SET TRAPCOMM 1 public
SNMP Trap Receiver [1] Trap Community: public setting success.
This setting will be applied after reboot.
```

**5.1.6 SNMP Summary**

The NMOA family supports SNMPv1, and SNMPv2c. SNMPv3 is not currently supported. A GUI (Graphical User Interface) in the form of a MIB browser or network management software can be established for remote control and monitoring using the SNMP interface on the NMOA unit. See the prior CLI section 5.1.5.13 on information on how to change the SNMP configuration.

**Community strings**

**Read Only Community:** This is an access privilege for general users like operators who are not allowed to modify configurations. Identical to USER account in CLI.

**Read/Write Community:** This is an access privilege for system administrators, who can modify product configurations. Identical to ADMIN in CLI

**Traps**

A "Trap" is generated during an alarm event, and information about this alarm event will be sent to one or more designated "trap receivers". The Trap IP address is the IP address for the Trap Receiver. Up to 5 Trap IP addresses can be assigned per each NMOA unit.

**Trap Enable:** Enables alarm transmission to a configured Trap IP address. Assign Trap IP addresses before Enabling the Traps associated with them.

**Trap Community:** The community name to be used by the device when

sending traps.

Table 10 Factory Default SNMP Settings

Item	Sub-command	Default Value
RO community	ROCOMM	PUBLIC
RW community	RWCOMM	PRIVATE
Trap IP	TRAP	0.0.0.0
Trap Enable	TRAPEN	OFF

See the prior CLI section 5.1.5.13 on information on how to change the SNMP configuration.

## 5.2 SNMP MIB Table

### 5.2.1 entPhysicalEntry

Table 11 entPhysicalEntry

entityMIB OID : 1.3.6.1.2.1.47				
Name	OID	Type	Access	E.T.C
EntPhysicalIndex	1.3.6.1.2.1.47.1.1.1.1.1	Integer32	RO	
EntPhysicalDescr	1.3.6.1.2.1.47.1.1.1.1.2	octets	RO	
entPhysicalVendorType	1.3.6.1.2.1.47.1.1.1.1.3	object identifier	RO	Not Used
entPhysicalContainedIn	1.3.6.1.2.1.47.1.1.1.1.4	Integer32	RO	Not Used
EntPhysicalClass	1.3.6.1.2.1.47.1.1.1.1.5	Integer32	RO	
EntPhysicalParentRelPos	1.3.6.1.2.1.47.1.1.1.1.6	Integer32	RO	Not Used
EntPhysicalName	1.3.6.1.2.1.47.1.1.1.1.7	octets	RO	

- entPhysicalIndex : entity physical index
- entPhysicalDescr : entity physical description
- entPhysicalVendorType : entity physical vendor type
- entPhysicalClass : entity physical class
- entPhysicalName : entity physical name

### 5.2.2 propertyEntry

Table 12 propertyEntry

propertyIdent OID : 1.3.6.1.4.1.5591.1.1				
Name	OID	Type	Access	E.T.C
ParameterOID	1.3.6.1.4.1.5591.1.1.1.1.1	object identifier	RO	
AlarmEnable	1.3.6.1.4.1.5591.1.1.1.1.2	octets	RO	
CurrentAlarmState	1.3.6.1.4.1.5591.1.1.1.1.3	Integer32	RO	
AnalogAlarmHIHI	1.3.6.1.4.1.5591.1.1.1.1.4	Integer32	RO	

AnalogAlarmHI	1.3.6.1.4.1.5591.1.1.1.1.5	Integer32	RO	
AnalogAlarmLO	1.3.6.1.4.1.5591.1.1.1.1.6	Integer32	RO	
analogAlarmLOLO	1.3.6.1.4.1.5591.1.1.1.1.7	Integer32	RO	
analogAlarmDeadband	1.3.6.1.4.1.5591.1.1.1.1.8	Integer32	RO	Not Used

- parameterOID : analog alarm parameter OID
- alarmEnable : analog alarm enable
- currentAlarmState : current alarm status of analog alarm parameter
- analogAlarmHIHI : analog alarm HIHI threshold value
- analogAlarmHI : analog alarm HI threshold value
- analogAlarmLO : analog alarm LO threshold value
- analogAlarmLOLO : analog alarm LOLO threshold value

**5.2.3 currentAlarmEntry**

Table 13 currentAlarmEntry

discretePropertyEntry OID : 1.3.6.1.4.1.5591.1.1.2.1				
Name	OID	Type	Access	E.T.C
CurrentAlarmOID	1.3.6.1.4.1.5591.1.1.2.1.1	object identifier	RO	
currnetAlarmAlarmState	1.3.6.1.4.1.5591.1.1.2.1.2	Integer32	RO	
currentAlarmAlarmValue	1.3.6.1.4.1.5591.1.1.2.1.3	Integer32	RO	

- currentAlarmOID : now, OID of generated alarm
- currentAlarmAlarmSate : Alarm state of generated alarm
- currnetAlarmAlarmValue : Alarm value of generated alarm

**5.2.4 discretePropertyEntry**

Table 14 discretePropertyEntry

discretePropertyEntry OID : 1.3.6.1.4.1.5591.1.1.3.1				
Name	OID	Type	Access	E.T.C
discreteParameterOID	1.3.6.1.4.1.5591.1.1.3.1.1	object identifier	RO	
discreteAlarmValue	1.3.6.1.4.1.5591.1.1.3.1.1	Integer32	RO	
discreteAlarmEnable	1.3.6.1.4.1.5591.1.1.3.1.1	Integer32	RO	
discreteAlarmState	1.3.6.1.4.1.5591.1.1.3.1.1	Integer32	RO	

- discreteParameterOID : discrete alarm parameter OID
- discreteAlarmValue : discrete alarm value
- discreteAlarmEnable : discrete alarm enable
- discreteAlarmState : discrete alarm status

**5.2.5 alarmsIdent**

Table 15 alarmsIdent

alarmsIdent OID : 1.3.6.1.4.1.5591.1.2			
Name	OID	Type	Access



alarmLogNumberOfEntry	1.3.6.1.4.1.5591.1.2.1	Integer32	RO
alarmLogLastIndex	1.3.6.1.4.1.5591.1.2.2	Integer32	RO
AlarmLogIndex	1.3.6.1.4.1.5591.1.2.3.1.1	Integer32	RO
alarmLogInformation	1.3.6.1.4.1.5591.1.2.3.1.2	Octets	RO
AlarmLogText	1.3.6.1.4.1.5591.1.2.4	Octets	RO

- alarmLogNumberOfEntry : Count of log information (1~100)
- alarmLogLastIndex : Last index of log index
- alarmLogIndex : log index (1 ~ 32767)
- alarmLogInformation : alarm log information
- \* log information format - Time : alarm type : commonNeStatus : OID : Alarm Value

5.2.6 **commonIdent**

Table 16 commonIdent

commonIdent OID : 1.3.6.1.4.1.5591.1.3				
Name	OID	Type	Access	Note
commonLogicalID	1.3.6.1.4.1.5591.1.3.1.1	Octets	R/W	emcore
CommonVendor	1.3.6.1.4.1.5591.1.3.1.1	Octets	RO	
commonModelNumber	1.3.6.1.4.1.5591.1.3.1.1	Octets	RO	
commonSerialNumber	1.3.6.1.4.1.5591.1.3.1.1	Octets	RO	
commonVendorInfo	1.3.6.1.4.1.5591.1.3.1.1	Octets	RO	
CommonReset	1.3.6.1.4.1.5591.1.3.1.1	Integer32	R/W	
commonAlarmDetectionControl	1.3.6.1.4.1.5591.1.3.1.1	Integer32	R/W	
commonNetworkAddress	1.3.6.1.4.1.5591.1.3.1.1	IP Address	RO	
commonTrapCommunityString	1.3.6.1.4.1.5591.1.3.1.1	Octets	R/W	PUBLIC
commonInternalTemperature	1.3.6.1.4.1.5591.1.3.1.1	Integer32	RO	
CommonTime	1.3.6.1.4.1.5591.1.3.1.1	Integer32	RO	
commonVarBindings	1.3.6.1.4.1.5591.1.3.1.1	Integer32	RO	
commonResetCause	1.3.6.1.4.1.5591.1.3.1.1	Integer32	RO	

- commonLogicalID : logical ID
- commonVendor : vendor
- commonModelNumber : model number
- commonSerialNumber : serial number of model
- commonVendorInfo : vendor information
- commonReset : software reset(write '1')
- commonAlarmDetectionControl : Detection control of all alarm parameters
- commonNetworkAddress : network address of system
- commonTrapCommunityString : trap community(default : public)
- commonInternalTemperature : temperature of OFA module
- commonTime : time(position value)
- commonVarBindings : value of binding
- commonResetCause : cause of latest reset

5.2.7 **commonMulticastGroup**

Table 17 commonMulticastGroup



commonMulticastGroup OID : 1.3.6.1.4.1.5591.1.3.3				
Name	OID	Type	Access	Note
commonMaxMulticastAddress	1.3.6.1.4.1.5591.1.3.3.1	Integer32	RO	
commonMulticastAddressIndex	1.3.6.1.4.1.5591.1.3.3.2.1.1	Integer32	RO	
commonMulticastAddressNumber	1.3.6.1.4.1.5591.1.3.3.2.1.2	Octets	R/W	

- commonMaxMulticastAddress : Maximum number of multicast address
- commonMulticastAddressIndex : Index multicast address
- commonMulticastAddressNumber : Address of multicast

5.2.8 heOpticalAmplifierGroup

Table 18 heOpticalAmplifierGroup

heOpticalAmplifierGroup OID : 1.3.6.1.4.1.5591.1.11.1.3				
Name	OID	Type	Access	Note
heOpAmpUnitOutputStatus	1.3.6.1.4.1.5591.1.11.1.3.1.1.1.1	Integer32	RO	
heOpAmpUnitOnOffControl	1.3.6.1.4.1.5591.1.11.1.3.1.1.1.2	Integer32	RO	
heOpAmpInputIndex	1.3.6.1.4.1.5591.1.11.1.3.1.1.2.1.1	Gauge32	RO	
heOpAmpInputPower	1.3.6.1.4.1.5591.1.11.1.3.1.1.2.1.2	Integer32	RO	
heOpAmpLaserIndex	1.3.6.1.4.1.5591.1.11.1.3.1.1.3.1.1	Integer32	RO	
heOpAmpLaserTemp	1.3.6.1.4.1.5591.1.11.1.3.1.1.3.1.2	Integer32	RO	
heOpAmpLaserBiasCurrent	1.3.6.1.4.1.5591.1.11.1.3.1.1.3.1.3	Gauge32	RO	
heOpAmpOutputIndex	1.3.6.1.4.1.5591.1.11.1.3.1.1.4.1.1	Gauge32	RO	
heOpAmpOutputPower	1.3.6.1.4.1.5591.1.11.1.3.1.1.4.1.4	Integer32	RO	
heOpAmpOutputGainType	1.3.6.1.4.1.5591.1.11.1.3.1.1.4.1.5	Integer32	RO	

- heOpAmpUnitOutputStatus : output status(on/off) of optical amplifier
- heOpAmpUnitOnOffControl : output status control of optical amplifier
- heOpAmpInputIndex : index of input power
- heOpAmpInputPower : input power value
- heOpAmpLaserIndex : index of LD
- heOpAmpLaserTemp : temp of LD
- heOpAmpLaserBiasCurrent : bias current of LD
- heOpAmpOutputIndex : index of output power
- heOpAmpOutputPower : value of output power
- heOpAmpOutputGainType : output power gain type(AGC/APC)

5.2.9 heBaselIdent

Table 19 heBaselIdent

heBaselIdent OID : 1.3.6.1.4.1.5591.1.11.2				
Name	OID	Type	Access	Note
HeCommonTime	1.3.6.1.4.1.5591.1.11.2.1.1.1.1.1	Octets	RO	
HeCommonTemperature	1.3.6.1.4.1.5591.1.11.2.1.1.1.1.2	Integer32	RO	
HeCommonSoftwareReset	1.3.6.1.4.1.5591.1.11.2.1.1.1.1.3	Integer32	RO	
heCommonAlarmDetectionControl	1.3.6.1.4.1.5591.1.11.2.1.1.1.1.4	Integer32	RO	
heCommonLogNumberOfEntries	1.3.6.1.4.1.5591.1.11.2.1.1.1.2.1	Integer32	RO	

HeCommonLogLastIndex	1.3.6.1.4.1.5591.1.11.2.1.1.1.2.2	Integer32	RO	
HeCommonLogIndex	1.3.6.1.4.1.5591.1.11.2.1.1.1.2.3.1.1	Gauge32	RO	
HeCommonLogOID	1.3.6.1.4.1.5591.1.11.2.1.1.1.2.3.1.2	Object Identifier	RO	
HeCommonLogValue	1.3.6.1.4.1.5591.1.11.2.1.1.1.2.3.1.3	Integer32	RO	
HeCommonLogState	1.3.6.1.4.1.5591.1.11.2.1.1.1.2.3.1.4	Integer32	RO	
HeCommonLogTime	1.3.6.1.4.1.5591.1.11.2.1.1.1.2.3.1.5	Octets	RO	
HeCommonLogText	1.3.6.1.4.1.5591.1.11.2.1.1.1.2.3.1.6	Octets	RO	

- heCommonTime : time
- heCommonTemperature : internal temperature of Optical Amplifier
- heCommonSoftwareReset : software reset(write '1')
- heCommonAlarmDetectionControl : detection control of all alarm parameters
- heCommonLogNumberOfEntries : count of log entries
- heCommonLogLastIndex : latest index of log
- heCommonLogOID : OID of alarm parameter
- heCommonLogValue : alarm value
- heCommonLogState : alarm state
- heCommonLogTime : activated time of alarm
- heCommonLogText : text information of alarm

**5.2.10 hePowerSupply**

Table 20 hePowerSupply

hePowerSupply OID : 1.3.6.1.4.1.5591.1.11.2.2			
Name	OID	Type	Access
HePsUnitDescription	1.3.6.1.4.1.5591.1.11.2.2.1.1.1.3	Octets	RO
HePsOutputIndex	1.3.6.1.4.1.5591.1.11.2.2.1.1.2.1.1	Integer32	RO
HePsOutputVoltage	1.3.6.1.4.1.5591.1.11.2.2.1.1.2.1.4	Integer32	RO

- hePsUnitDescription : description(AC 110~220 / DC -48) of power supply module
- hePsOutputIndex : index of power supply module
- hePsOutputVoltage : output voltage of power supply module

**5.2.11 heFans**

Table 21 heFans

heFans OID : 1.3.6.1.4.1.5591.1.11.2.3			
Name	OID	Type	Access
HeFanUnitAlarm	1.3.6.1.4.1.5591.1.11.2.3.1.1.1.1	Integer32	RO
HeFanStatusIndex	1.3.6.1.4.1.5591.1.11.2.3.1.1.2.1.1	Gauge32	RO
HeFanStatusAlarm	1.3.6.1.4.1.5591.1.11.2.3.1.1.2.1.3	Integer32	RO

- heFanUnitAlarm : status of fan('1' is ok, another value is not ok)
- heFanStatusIndex : index of fan
- heFanStatusAlarm : status of fan('1' is ok, another value is not ok)

5.2.12 SNMP Trap Information

During a typical SNMP GET transaction, the SNMP Manager (or console) will initiate a request for data and the SNMP Agent (in this case the NMOA) will respond with the requested data. When an alarm occurs, an SNMP Trap containing the alarm information is created by the SNMP Agent, and is subsequently sent to the SNMP Manager without a prior request from the recipient. It is expected the SNMP Manager will be prepared to receive the trap with the SNMP Trap Receiver properly configured for this feature.

Please note that an SNMP TRAP is generated for all alarm activations.

TRAP format  
 Binding #1: sysUpTime  
 Binding #2: snmpTrapOID  
 Binding #3: Alarm OID and value

6 PERFORMANCE CHECK

6.1 Precautions for Testing

After completing installation of the NMOA8100 Series EDFA as described in the **GETTING STARTED** section be sure to final check that the EDFA is securely mounted to an equipment rack and, all electrical connections are correctly established.

Work in an ESD controlled environment and observe ESD precautions including the use of a grounded wrist strap when handling equipment.

Never look into the end of an optical cable or an exposed optical bulkhead connector attached to an optical output device this is operating. Laser radiation is invisible, and direct exposure can severely injure the human eye.

6.2 Measuring Instruments

The required instruments for the performance test and descriptions are listed below in Table 22.

Table 22 Instruments for Performance Test

Instrument	Performance
Optical Source or Optical Transmitter	Input Optical Signal Source to the EDFA Operational wavelength 1550nm
Variable Optical Attenuator	Controls the optical input power
Optical Power Meter	Measures the optical power (calibrated to 1550 nm for accuracy)

### 6.3 Performance Test Procedure

1. Confirm that all power switches for all equipment are in the OFF state.
2. Clean all fiber optical bulk heads and patch cords fiber end faces (see section **Connecting Optical Fiber Patch Cords** for details)
3. With an optical fiber patch cord, connect the optical source or transmitter to the input of the optical power meter.
4. Turn on the power meter.
5. Turn on the optical source and measure the optical power.
6. Make sure the Optical power measured from the source is above the minimum optical input power threshold for the EDFA, and below the maximum input power threshold for the EDFA, which is described in the test report included with the NMOA8100 shipping carton, or referring to the model specific datasheet.
7. Turn off the source. If there is a key switch on the source, it can be turned to the OFF position.
8. Disconnect the optical power meter, and connect the source to the input of the NMOA8100 EDFA (shown in the diagram below as Device Under Test - DUT).
9. Confirm the measurable power range of the optical power meter. A typical EDFA optical output power level can be very high, and the optical power meter may be irreversibly damaged if it's input power specifications are violated. If the input power specification range is lower than the specified output power of the EDFA, an optical attenuator must be inserted between the output of the EDFA and the input of the optical power meter.
10. Finally, connect the output of the EDFA directly (or through a variable optical attenuator if necessary) to an optical power meter with an optical fiber patch cord(s).
11. Turn on the power meter.
12. Power up the EDFA with the key switch OFF, and wait for it to initialize.
13. Turn the key switch for the source to ON.
14. Turn the key switch for the EDFA to ON.
15. Under normal operating conditions, with LASER ON state, and the optical input power is within the optical input power range of the EDFA, confirm that the optical output power of the EDFA is within specification.

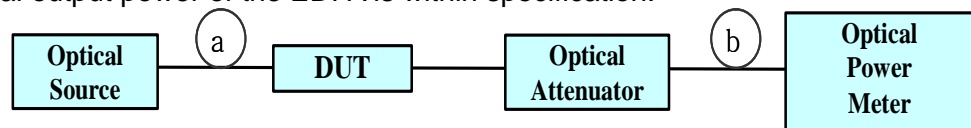

Figure 1. NMOA8100 Series EDFA Measuring Instrument Setup

### 6.4 Alarm Test Procedure

The LOS (Loss of Signal) Alarm of the NMOA8100 Series EDFA occurs when

the optical input power of the EDFA is lower than the minimum optical input power threshold of the unit (see the TEST REPORT for the factory measured value).

It is possible to check the LOS Alarm, by inserting a variable optical attenuator between the optical source and the input to the NMOA8100 EDFA. The input power of the EDFA can be adjusted by using the optical variable attenuator to a value below the minimum optical input signal level.

Once the optical power drops below the input power threshold, the LOS Alarm should activate. Under this condition, the NMOA8100 Series EDFA will change it's state to Automatic Laser Shutdown (ALS) mode, and the color of the Status LED on the front panel will change to red.

The state information watch program of the NMOA8100 Series EDFA will log both the activated event type and the event time. If SNMP is enabled and configured, an SNMP trap will be sent.

If the Buzzer selection is in the ON state, the Buzzer sound will activate.

The Buzzer sound can be cancelled by pushing any switch on the front panel or by selecting Buzzer OFF via the front panel interface (see section 4.2.3 for details).

If the Buzzer selection in the LCD menu is in the OFF state the Buzzer sound will not sound but the event type and time values are logged. When the optical input power of the NMOA8100 Series EDFA returns to normal input range, the LED on the front panel and the Buzzer sound automatically turn off. The alarm clear condition will also be automatically logged and SNMP trap sent.

## **7 TROUBLESHOOTING**

### **7.1 Troubleshooting Precautions**

This section of the manual will provide an overview of how to trouble shoot abnormal conditions of the NMOA8100 series EDFA. It is expected that a properly trained and accredited network operator with a general understanding of optical networking safety, theory and system operation will attempt to resolve the issue.

Any other repair attempts except those explained in this chapter may cause unexpected damage or problems to the unit or installation.

Careful treatment and caution is required for all trouble shooting procedures.

### **7.2 Basic Troubleshooting Procedures**

The front panel of the EDFA contains a Laser LED and a Status LED. In normal operation, both LED's will be solid Green.

Problems may be indicated by anything other than solid Green LED's. The table below provides a summary of alarm states and possible causes.

Table 23 Alarm States and Causes

Case	Laser LED	Status LED	7.2.1.1.1.1.1.1 Causes
1	Off	Off	- Unless two LED's have malfunctioned, this could indicate the unit is off, or electric power is not provided.
2	Red	Red	- The optical input power of the EDFA does not meet the minimum requirement.
3	Green	Red	- The optical output power of the EDFA does not meet the specified output power.
4	Green	Yellow	- The bias current of the Pump Laser Diode of the EDFA is abnormal. - Case Temp is out of the specified range - FAN failure
5	Green to Red	Yellow to Red	The internal temperature of the Pump Laser Diode of the EDFA is out of the specified range.

- Case 1: Check the power switch and power cord to ensure electric power is provided properly. Disconnect and isolate all power sources before checking power supply fuses.
- Case 2: Measure whether the optical input power of the EDFA from the optical source or optical transmitter satisfies the minimum optical input power condition of the EDFA. If the optical input power of the EDFA is satisfied, attempt to clean the fiber face surface of the optical input of the EDFA. See **Connecting Optical Fiber Patch Cords** in section 2.6 for further details.
- Case 3: Check the Laser ON/OFF state on the Laser Control menu.
- Case 4: Check the fans and confirm unrestricted airflow. Make sure environmental operating conditions are not being exceeded. Check for Pump Laser Diode bias alarms in the user interface.
- Case 5: In the case where the Status LED turns yellow at first, followed by both Laser and Status LED's turning red, the internal pump laser diode internal temperature is abnormal. The laser diode may require either an adjustment or a replacement.

**If you identify the problem as shown in the Table or have an unidentified problem you must stop operating the EDFA immediately, and please contact Emcore for support.**

## 8 CLAIMS AND REPACKAGING

### 8.1 Claims

Immediately inform Emcore and, if necessary, the carrier, if

- The contents of the shipment are incomplete
- The unit or any of its components are damaged or defective
- The unit does not pass the initial inspection

In the event of carrier responsibility, Emcore will allow for the repair or replacement of the unit while a claim against the carrier is being processed.

### 8.2 Returning Shipments to Emcore

Emcore will only accept returns for which an approved Return Material Authorization (RMA) has been issued. This number must be obtained prior to shipping any material to Emcore. The owner's name and address, the model number and full serial number of the unit, the RMA number, and an itemized statement of claimed defects must be included with the return material.

Ship the return material in **the original shipping container and packing material**. The figure below shows the correct placement of the original packing material in the original inner box.

**NOTE:** *In the event of a reshipment back to the manufacturer, any additional damage caused by not using the original boxes will be considered the responsibility of the customer.*

If the original shipping container and packing material are not available, typical packaging guidelines are as follows:

1. Wear an anti-static wrist strap and work in an ESD controlled area.
2. Wrap the unit in anti-static packaging. Use anti-static connector covers, as applicable.
3. Pack the unit in a reliable shipping container.
4. Use enough shock-absorbing material (10 to 15 cm or 4 to 6 in on all sides) to cushion the unit and **prevent it from moving inside the container**. Pink poly anti-static foam is recommended.
5. Seal the shipping container securely.
6. Clearly mark FRAGILE on its surface.
7. Always provide the model and serial number of the unit and, if necessary, the RMA number on any accompanying documentation.

8. Please contact the RMA department, using the contact information at the beginning of this document, to provide an RMA number and a shipping address.



Figure: (a) Original packaging material placement with in the box and (b) with wrapped EDFA contained in original box.

Information contained herein is deemed to be reliable and accurate as of issue date. EMCORE reserves the right to change the design, specifications or the user manual at any time without notice. EMCORE, and the EMCORE logo are trademarks of EMCORE Corporation.