

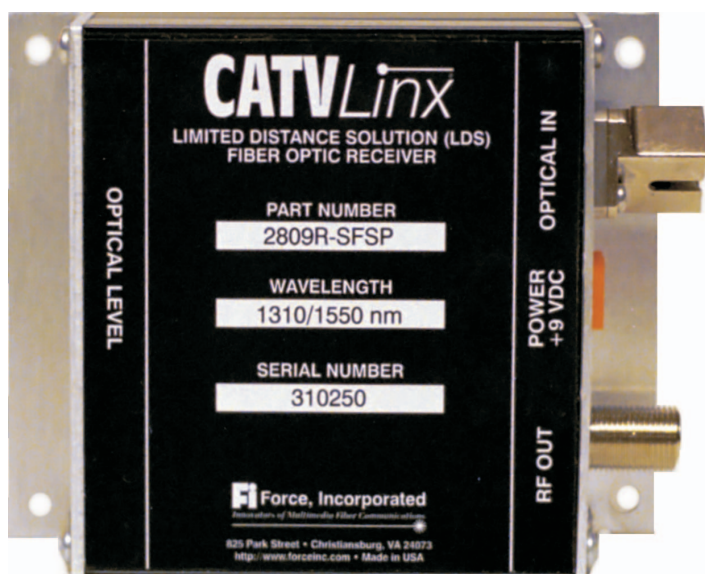

# Model 2809

LDS CATV Receiver

IOM2809  
Revision 2.0, March 2004



## Instructions for Installation and Use

*Read this manual before installing or using this product.  
Observe all safety warnings and cautions.*

Copyright © 2004 by Force, Incorporated. All rights reserved. Force, Incorporated reserves the right to make changes to the product described in this document in the interest of document improvement.





# Preface

## About this Manual

This manual explains how to configure and install the Model 2809 LDS CATV receiver. It is intended for engineers and technicians who will install the 2809R receivers with companion transmitter, Model 2806 (see IOM2806). While this guide provides basic information on how to configure and install the units, it assumes that you as the user are familiar with:

- the installation and manipulation of electronic and fiber optic equipment
- the installation and manipulation of CATV video/audio equipment

This manual is divided into the following sections:

- Section 1, page 1: Describes the LDS CATV receiver, lists technical specifications, performance graphs, system applications, and ordering information.
- Section 2, page 7: Describes the installation of the LDS CATV receiver, connections, and safety precautions.
- Section 3, page 11: Describes the operation of the LDS CATV link, troubleshooting, and user maintenance.

A quick-reference index completes the user manual.

## Related Documentation

- IOM2806: User Manual for Model 2806 LDS Transmitter
- AN123: North American Television Frequencies
- AN128: Care and Feeding of Analog CATV Fiber Optic Links
- AN141: System Solutions for CATV HFC Networks
- *Fiber Optic Reference Guide, 3rd Edition*. by David R. Goff (Focal Press 2002): General theory and operation of fiber optic units.
- Web Site: Our web site, <http://www.forceinc.com> may be used to download the latest versions of this manual.



## Technical Support

If you encounter any kind of problem after reading this manual, contact your local distributor or a Force, Inc. Applications Engineer. To reach technical support:

On the Web:	<a href="http://www.forceinc.com">http://www.forceinc.com</a>
By Phone (Monday through Friday 8:00 am to 5:00 pm EST):	USA (800) 732-5252 TEL (540) 382-0462
By Fax:	(540) 381-0392
By Email:	<a href="mailto:sales@forceinc.com">sales@forceinc.com</a>

## Warranty

Force, Incorporated standard products are warranted to be free from defects in materials and workmanship, meeting or exceeding factory specified performance standards for a period of three (3) years from date of purchase.

## Force Obligations

Force will, at its discretion and expense, repair any defect in materials or workmanship or replace the product with a new product. Force will, upon receipt of the return, evaluate the product and communicate to the customer the nature of the problem, and determine if the claim falls under warranty coverage.

If during the warranty period, Force is unable to repair the product to the original warranted state within a reasonable time, or if subcomponents of the unit have been obsoleted or discontinued, then Force has the option to provide an equivalent unit.

## Exclusions

This warranty does not extend to any product that has been damaged due to acts of God, accident, misuse, abuse, neglect, improper system design or application, improper installation, improper operation or maintenance, or connection to an improper voltage supply.

The Force warranty does not cover fuses, batteries, and lamps. Modifications or alterations of Force products (including but not limited to installation of non-Force equipment or computer programs), except as authorized by Force, will void this warranty. Removal or breaking of the seals on the product will also void the warranty. In addition, cost of repair by unauthorized persons within the warranty period of the product will not be covered by Force, Incorporated. Such repairs will void the warranty.



Force, Incorporated makes no other representation or warranty of any other kind, express or implied, with respect to the goods, whether as to merchantability, fitness for a particular purpose, or any other matter. Force, Incorporated's liability shall not include liability for any special, indirect or consequential damages, or for any damages arising from or attributable to loss of use, loss of data, loss of goodwill, or loss of anticipated or actual revenue or profit, or failure to realize expected savings, even if Force, Incorporated has been advised of the possibility of such damages. This warranty constitutes Force, Incorporated's entire liability and the customer's sole remedy for defects in material and workmanship.



# Contents

<b>Preface</b> .....	<b>ii</b>
<b>Section 1 Product Technical Bulletin</b> .....	<b>1</b>
1.1 Product Overview.....	1
1.2 FCC Notice .....	1
1.3 Optical, Video, Electrical Characteristics .....	1
1.4 Environmental and Physical Characteristics .....	2
1.5 Specification Notes .....	2
Figure 1.1 In-Band Frequency Response .....	2
Figure 1.2 Expanded Frequency Response .....	3
Figure 1.3 CNR vs. Receiver Optical Input at 77 Channels .....	3
Figure 1.4 RF Output Level Behavior of 2809R.....	4
1.6 Applications.....	5
Figure 1.5 Private Network Configuration .....	5
1.7 Ordering Information.....	5
<b>Section 2 Installation Instructions</b> .....	<b>7</b>
2.1 General Installation Requirements.....	7
2.2 Items Provided.....	7
2.3 Items Required .....	7
2.4 Inspection .....	8
2.5 Module Placement.....	8
2.6 Unit Outline Drawing .....	8
Figure 2.1 Model 2809 <b>CATV</b> <i>Linx</i> <sup>®</sup> LDS CATV Receiver.....	8
2.7 Connections .....	9
2.8 Safety Precautions .....	9
2.8.1 Laser Safety Procedures .....	9
2.9 Shipping and Handling Precautions.....	10
2.10 Storing the Unit.....	10



**Section 3 Operating Instructions ..... 11**

- 3.1 Theory of Operation ..... 11
  - Figure 3.1 Model 2809 Block Diagram ..... 11
- 3.2 Power-up and Operation ..... 11
- 3.3 Measuring RF Input Levels at the Transmitter ..... 12
- 3.4 Performance Verification..... 12
- 3.5 Cleaning ..... 13
  - 3.5.1 Connector Cleaning ..... 13
  - 3.5.2 Connector Handling ..... 14
- 3.6 Troubleshooting..... 14
- 3.7 Repair Service ..... 14

**Index ..... 15**



# Section 1 Product Technical Bulletin

## 1.1 Product Overview

The Force, Incorporated CATV<sup>Linx</sup>® Model 2809 Limited Distance Solution (LDS) CATV Receiver, working with the Model 2806 LDS transmitter, provides a low-cost system for transporting 77 channels of VSB/AM modulated signals over a single-mode optical fiber. The LDS link provides excellent performance up to 10 km with full channel loading, high sensitivity, and 40-550 MHz of usable bandwidth. With a wide optical input range of -8.0 dBm to +4.5 dBm and an RF output of +18 dBmV at 0 dBm optical input, the Model 2809 allows high quality signal transport for intra-facility limited distance applications, such as corporate CATV delivery and FTTC where cost, small size, and performance are major considerations. This low-cost system allows CATV providers with the ability to provide a reliable limited distance fiber optic video distribution system.

## 1.2 FCC Notice

The Model 2809 has been tested and found to comply with the limits for a Class A digital device, pursuant to Part 15 of the FCC Rules. These limits are designed to provide reasonable protection against harmful interference when the equipment is operated in a commercial environment. This equipment generates, uses, and can radiate radio frequency energy and, if not installed and used in accordance with the instructions in this manual, may cause harmful interference, in which case the user must correct the interference at the user's own expense. Compliance with applicable regulations depends on the use of shielded I/O cables. The user is responsible for procuring the appropriate cables.

## 1.3 Optical, Video, Electrical Characteristics: @ 25 °C, SM Fiber (Note 9)

	Min.	Typ.	Max.	Units	Notes See Section 1.5
Operating Wavelength	1290	1310	1330	nm	
Operating Wavelength	1490	1550	1610	nm	
Optical Input Power	-8.0		+4.5	dBm	
Channel Loading			77	Channels	
Bandwidth	40		550	MHz	
Required Fiber Bandwidth	2,000			MHz	
Output Impedance		75		Ohms	
RF Output Level		+18		dBmV	1, 2



	Min.	Typ.	Max.	Units	Notes
Output Return Loss		16		dB	See Section 1.5
Composite Second Order (CSO)		-63		dBc	
Composite Triple Beat (CTB)		-66		dBc	
Carrier-to-Noise Ratio (CNR)	See Figure 1.3, page 3.				3
Backreflection Tolerance			-50	dB	5
Power Supply Voltage	+8		+10	V <sub>DC</sub>	6
Power Dissipation		2		Watts	

**1.4 Environmental and Physical Characteristics**

	Min.	Typ.	Max.	Units	Notes
Operating Temperature Range	0		+50	°C	See Section 1.5.
Storage Temperature Range	-20		+70	°C	
Humidity	5		95	%	8
Weight		6.6		oz.	
		187		g	
Physical Dimensions	3.75 x 2.95 x 1.12			in.	
	95 x 75 x 29			mm	

**1.5 Specification Notes**

- 1) The 2809 receiver does not include an adjustable RF output level. The unit is designed to give approximately an RF output of +18 dBmV per channel at an optical input of 0 dBm. The RF level will change by 2 dB for every 1 dB change in optical input. At an optical input of -8.0 dBm, the RF level will be about +2 dBmV per channel. At an optical input of +4.5 dBm, the RF level will be approximately +27 dBmV per channel.
- 2) Figure 1.1 shows the typical frequency response of a 2806T/2809R link over the specified frequency range. The gain flatness is ±1.5 dB over this range. The flatness is typically less than ±0.1 dB over a standard 6 MHz channel bandwidth. See Application Note AN123 for additional information on North American Television Frequencies.

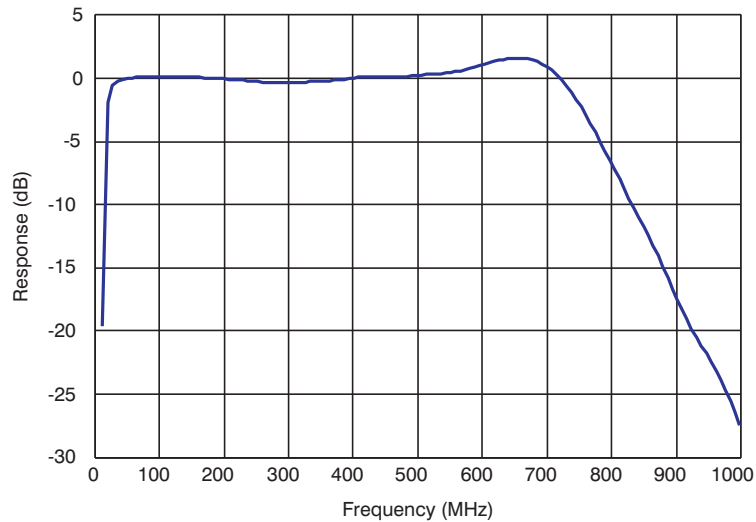

Figure 1.1 In-Band Frequency Response



Figure 1.2 shows an expanded view of the frequency response of a typical 2806T/2809R link.

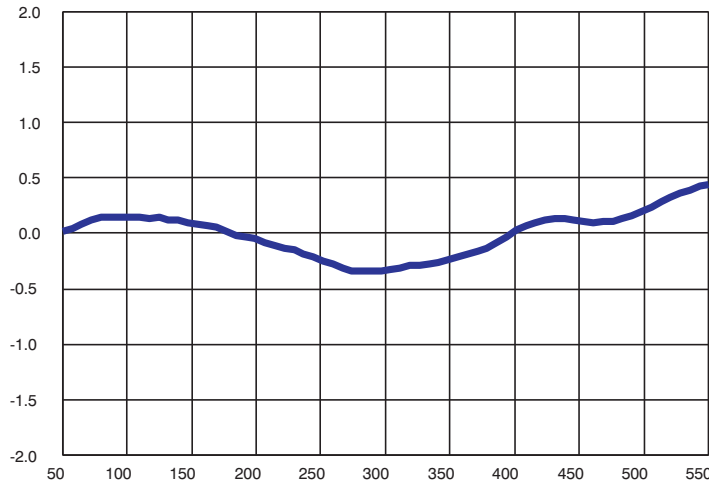

Figure 1.2 Expanded Frequency Response

- 3) Figure 1.3 show the CNR versus received optical input power and number of channels. The horizontal axis is the amount of optical light that reaches the receiver. (It is not the loss between the transmitter and receiver.) The vertical axis shows the CNR.

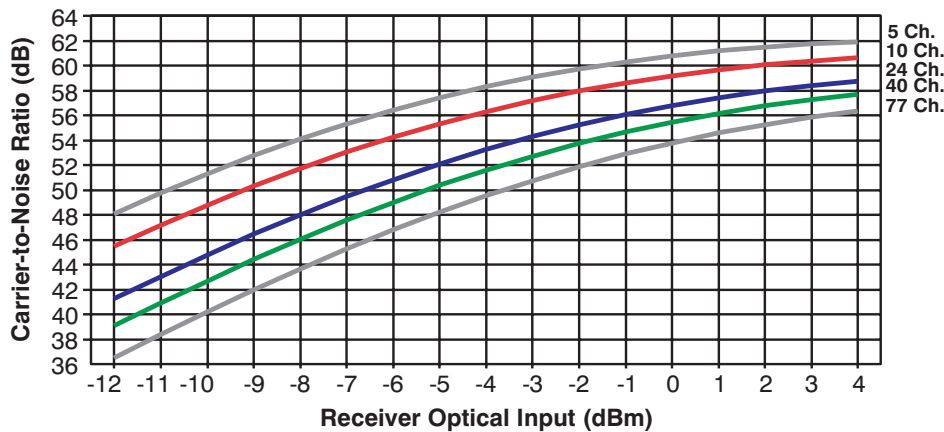

Figure 1.3 CNR vs. Receiver Optical Input at 77 Channels (2806T with 2809R)

The link CNR is usually specified for a received optical power of -3 dBm or more. Thus, a 2806T-SCSP optical transmitter, with an optical output of +4.5 dBm, will provide optimal performance with up to 7.5 dB of optical loss at full channel loading. If lower channel loading is used, then the link can operate at higher optical losses and still provide exceptional CNR.

Typical transmitter output is +4.5 dBm, so a received optical power of -3.5 dBm corresponds to an optical loss of 8 dB. Five curves are plotted; the top curve is the typical result when only 5 channels are transmitted through the link. It can be seen that very high CNR results and in fact the output is quite usable with receiver optical inputs as low as -12 dBm, corresponding to 16 dB of optical loss! As the channel loading gets higher, the maximum achievable CNR drops.

- 4) Figure 1.4 shows the RF output behavior of the 2809 receiver. The blue line shows the nominal Rf output level versus optical input. Over the optical input range from -8 dBm to +4.5 dBm, the RF output level varies by 2 dB for every 1 dB drop in optical input power. Operating below -8 dBm optical input will cause the CNR to degrade rapidly for channel loads of 77 or more.

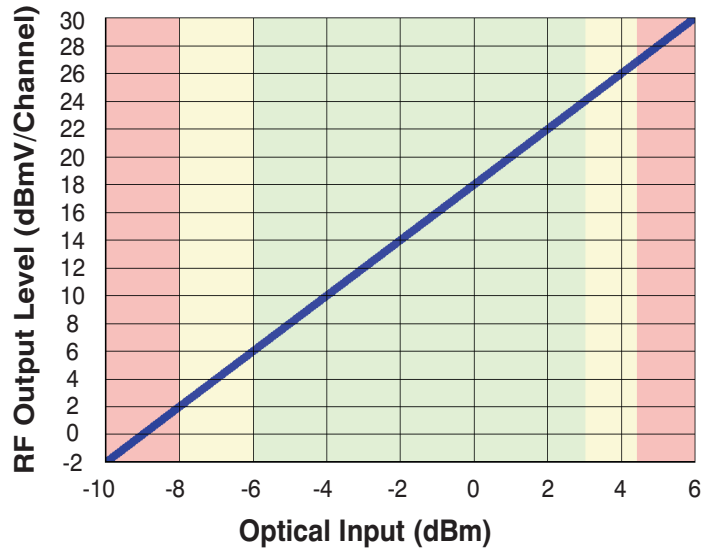

Figure 1.4 RF Output Level Behavior of 2809R

In Figure 1.4 the central green area is the region that should be used for new designs. So while the receiver is rated to optical input powers as low as -8 dBm, it is recommended that -6 dBm be the minimum for a newly installed system. That leaves 2 dB of margin for the optical power to drop and still provide good operation. The yellow region is the safety band. The unit is rated to operate in this region; however, the margin will probably be inadequate for a newly installed design. The red regions are outside the recommended operating parameters of the 2809R and must be avoided to ensure reliable operation.

- 5) **This product must be used only with APC type optical connectors or fusion spliced connections.** There is some folklore which suggests that the only critical backreflection is the one closest to the transmitter. Our experience does not support that view. We find that **all** backreflections matter, regardless of their distance from the transmitter.
- 6) Force, Inc. recommends using the Model PS095 wall-mount power supply (see TB043) with the Model 2809 receiver.
- 7) Most parameters are relatively unaffected by varying temperature. A moving air environment is recommended at ambient temperatures above +35°C.
- 8) Humidity is RH non-condensing.
- 9) The CATV<sup>Linx</sup>® LDS CATV receiver is optimized for single-mode operation only. Use on multimode fiber is not recommended, even for short distances, because of the large amount of modal noise that could result.



### 1.6 Applications

Figure 1.5 illustrates a small private CATV network, such as one might find in an educational or business campus, where local cable feeds can be routed throughout the campus to multiple receiver sites.

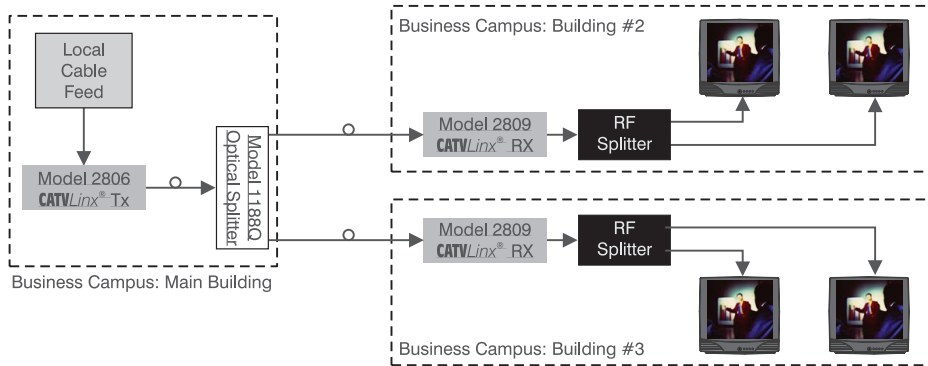

Figure 1.5 Private Network Configuration

### 1.7 Ordering Information

Part Number	Description
2809R-SFSP	LDS CATV VSB/AM Rx, SM, 1310/1550 nm, SC/APC Connector
2809R-SFAP*	LDS CATV VSB/AM Rx, SM, 1310/1550 nm, FC/APC Connector

\*Note: The FC/APC interface uses the "wide-key" standard. This means that the units are optimized for use with FC/APC connectors that have a 2.14 mm wide alignment key. "Narrow-key" FC/APC connectors (2.02 mm) may be used but will produce inferior results. Standard FC/PC connectors have a 2.36 mm wide key and cannot be plugged into either unit.



**Notes:**



# Section 2 Installation Instructions

## 2.1 General Installation Requirements

The installation of these units is very simple. There are no special unpacking instructions, except that care should be taken to handle units gently. Fiber optic links are sensitive electronics devices that should be handled with care. Like most electronics, they are susceptible to ESD. Proper ESD techniques, such as wearing a wrist grounding strap, should be observed at all times when handling a unit. The units should not be dropped. No assembly is required.

Do not install the equipment near sources of excessive heat, such as furnace outlets or above heat producing units, such as large power supplies and tube-type equipment. Observe temperature and relative humidity requirements specified in Section 1.3, page 2.

## 2.2 Items Provided

The following is a list of items provided with each Model 2809 LDS CATV Receiver:

Qty.	Mfr.	P/N	Description
AR	Force, Inc.	2809R-SFXX	<b>CATV</b> <i>Linx</i> <sup>®</sup> LDS CATV Rx, SM, 1310/1550 nm, SC/APC Connector Standard, FC/APC Optional
1 per connector	Any	Any	Active Device Receptacle Caps for RF and Optical Connectors

## 2.3 Items Required

Qty.	Mfr.	P/N	Description
AR	Force, Inc.	2806T-SCXX	<b>CATV</b> <i>Linx</i> <sup>®</sup> 77 Ch. LDS CATV Tx, SM, 1310 nm, SC/APC Connector Standard, FC/APC Optional
1 per Rx	Force, Inc.	PS095-1	Power Supply for Receiver, +9 Volts DC, 500 mA, 2-Pin Power Connector
4 per unit	Any	Any	6-32 Panhead Mounting Screws with Lock Washers and Nuts
AR	Any	Any	Straight Screwdriver
AR	Any	Any	9/125 μm Single-mode Fiber

2.4 Inspection

Remove the unit from its shipping container. Any in-shipment damage that may have occurred should be visually apparent. Look for bent or damaged connectors or mounting brackets. Claims for damage incurred in shipment should be made directly to the transportation company in accordance with their instructions. Save the shipping cartons until installation and performance verification are completed.

2.5 Module Placement

Units may be mounted in any orientation on most flat, dry surfaces. Secure pan-head screws through mounting holes provided at the base of the module. If the unit is placed in a location where temperatures may exceed 38°C (100°F), a good heat sink should be secured. The use of silicone thermal pads is recommended between the module and the plate to maximize heat transfer.

2.6 Unit Outline Drawing

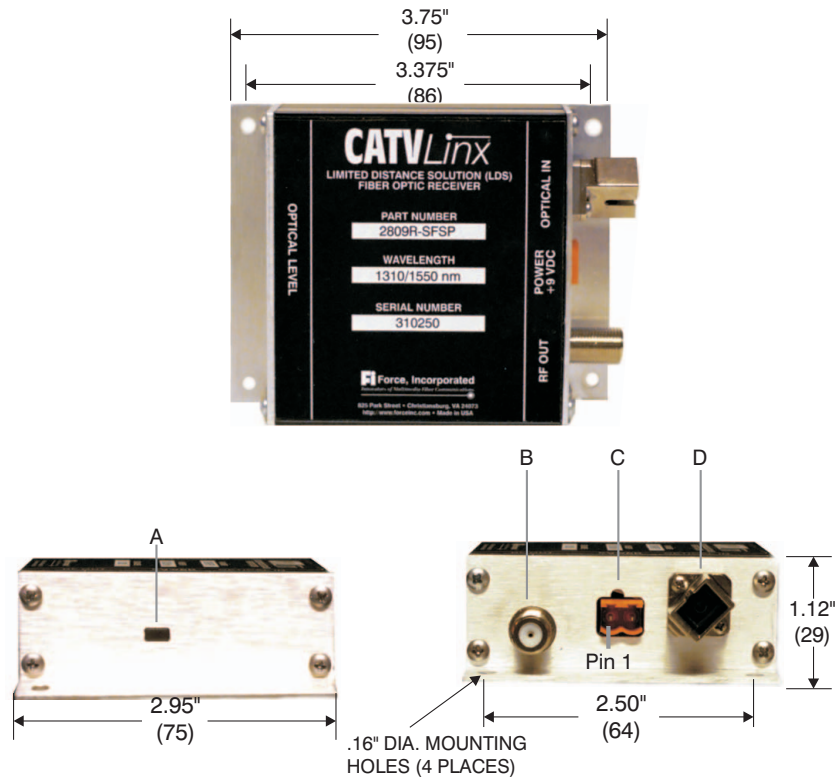

- A. Optical Level LED (Tri-colored LED): Indicates that the unit is receiving sufficient optical power. If the optical input is too low, the LED will be yellow. If the optical input is too high, the LED will be red.
- B. RF Out (F Connector): RF output from the receiver.
- C. Power (2-Pin Weidmuller Connector): Interface connector for the Model PS095-1 wall-mount power supply, which provides +8 to +10 Volts DC power to the receiver. See Section 2.7, page 9 for pin connections.
- D. Optical In (SC/APC Standard, FC/APC Optional): Optical input to the receiver.

**WARNING**

Invisible laser radiation emitted from the fiber that attaches to this connector. Avoid direct eye contact with the beam.

Figure 2.1 Model 2809 CATV<sup>Lin</sup>x<sup>®</sup> LDS CATV Receiver  
(Dimensions in parentheses are in millimeters.)



## 2.7 Connections

Connector Name	Connector Type	Connector Function	
Optical In	SC/APC or FC/APC*	Optical Input	
	It is imperative that backreflections be controlled to very low levels. This product must be used only with angle physical contact (APC) connectors.		
RF Out	F Connector	RF Output	
Power +9 VDC	2-Pin Weidmuller Connector	Pin	Function
		1	+8 to +10 Volts DC (+9 Volts DC Typ.)
		2	Ground

\*Note: The FC/APC interface uses the “wide-key” standard. This means that the units are optimized for use with FC/APC connectors that have a 2.14 mm wide alignment key. “Narrow-key” FC/APC connectors (2.02 mm) may be used but will produce inferior results. Standard FC/PC connectors have a 2.36 mm wide key and cannot be plugged into either unit.

## 2.8 Safety Precautions

The optical emission from the transmitters used with this product are laser-based Class IIIb, as are the emission from the optical connector that connects to the receiver optical port. Class IIIb laser emissions may present eye hazards if improperly used. **NEVER USE ANY KIND OF OPTICAL INSTRUMENT TO VIEW THE OPTICAL OUTPUT OF THE UNIT.** As always, be careful when working with optical fibers. Fibers can cause painful injury if they penetrate the skin.

### 2.8.1 Laser Safety Procedures

- 1) **ALWAYS** read the product data sheet and the laser safety label before powering the product. Note the operating wavelength, optical output power, and safety classification.
- 2) If safety goggles or other eye protection are used, be certain that the protection is effective at the wavelength(s) emitted by the device under test **BEFORE** applying power.
- 3) **ALWAYS** connect a fiber to the output of the device **BEFORE** power is applied. Power should never be applied without an attached fiber output. If the device has a connector output, a connector should be attached that is connected to a fiber. This ensures that all light is confined within the fiber waveguide, virtually eliminating all potential hazard.
- 4) **NEVER** look in the end of a fiber to see if light is coming out. **NEVER!** Most fiber optic laser wavelengths (1310 nm and 1550 nm) are totally invisible to the unaided eye and will cause permanent damage. Shorter wavelength lasers (e.g. 780 nm) are visible and are very damaging. Always use instruments, such as an optical power meter, to verify light output.
- 5) **NEVER NEVER NEVER** look into the end of a fiber on a powered device with **ANY** sort of magnifying device. This includes microscopes, eye loupes, and magnifying glasses. This **WILL** cause a permanent, irreversible burn on your retina. Always double check that power is disconnected before using such devices. If possible, completely disconnect the unit from any power source.
- 6) If you have questions about laser safety procedures, please call Force, Incorporated for assistance before powering your product. A Sales Engineer or Applications Engineer may be reached at (540) 382-0462.

- 7) Laser safety classes for the Model 2805 are as follows:

Class	Wavelength Range	Optical Power Accession Limits
IIIb	180 nm to 400 nm	Varies with $\lambda$ and exposure time. 0.5 Watt
	400 nm to $10^6$ nm	

## 2.9 Shipping and Handling Precautions

The units are, in general, very rugged and can withstand the stresses of most shipping and handling circumstances. However, the following precautions should be taken:

- 1) When the units are shipped they should be wrapped in a protective material, such as bubble wrap, to protect against excessive jarring and to prevent damage to the external finish of the units. Always use packing material to separate multiple units that are packaged together.
- 2) Care should be taken not to drop or strike the units in any way, especially around the optical connectors.
- 3) The units should never be submersed in any liquid. **SEVERE SHOCK HAZARD!**

## 2.10 Storing the Unit

If a unit is to be out of use for an extended period of time, the following steps should be taken to ensure the preservation of the unit:

- 1) The storage temperature range is  $-20^{\circ}\text{C}$  to  $+70^{\circ}\text{C}$ .
- 2) A low humidity environment is preferable for long term storage.
- 3) All connectors should be covered with active device receptacle caps.



## Section 3 Operating Instructions

### 3.1 Theory of Operation

The 2809 is a sophisticated, state-of-the-art CATV receiver. It provides an impressive set of capabilities in an extremely small package. Key features include:

- Low power operation
- Very cost effective
- Very wide optical input range
- Exceptional CNR performance over the full optical input range
- High output RF level

Figure 3.1 shows a block diagram of the 2809R.

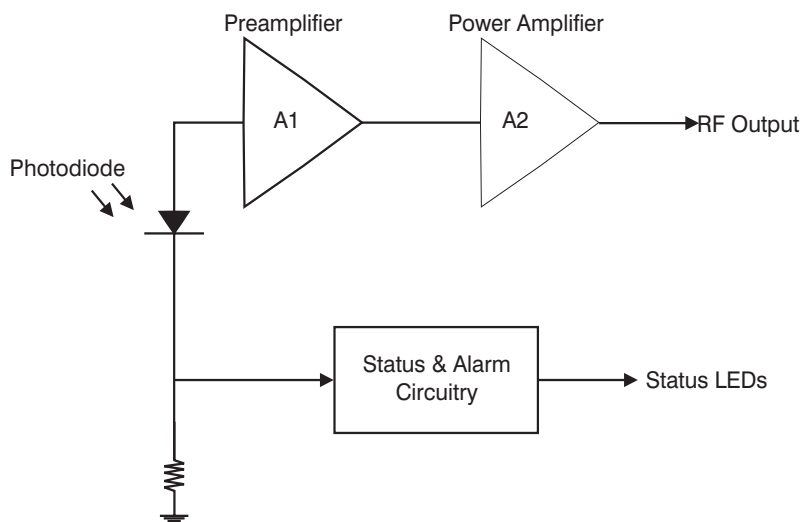

Figure 3.1 Model 2809 Block Diagram

### 3.2 Power-up and Operation

- 1) Install the links as described in Section 2, page 7.
- 2) Measure the RF level BEFORE making any connections to the transmitter. This measurement is described in Section 3.3, page 12.
- 3) Clean the optical connectors. See Section 3.5, page 13 for cleaning instructions. Be sure all optical connectors are APC type.
- 4) Connect the optical fiber to the transmitter and the receiver. Be sure that the fiber has continuity and less than the maximum allowable optical loss. Also be

certain that the fiber is the proper size. This product can only be used with single-mode fiber. The input power to the Rx must be less than +4.5 dBm. The units will work back-to-back with the Model 2806 transmitter.

- 5) Connect the RF source (VCR, camcorder, cable television, etc.) to the RF input on the transmitter.
- 6) Connect the RF output on the receiver to the monitor input. The monitor input should present a 75 Ohm impedance.
- 7) Connect the AC power cord to the transmitter and the PS095 wall-mount power supply to the receiver.

#### WARNING

OPTICAL LASER RADIATION IS PRESENT AT THE TRANSMITTER OPTICAL CONNECTOR AND THE FIBER THAT ATTACHES TO THE RECEIVER OPTICAL CONNECTOR WHEN THE UNIT IS ACTIVATED. AVOID DIRECT EYE EXPOSURE TO THE BEAM.

- 8) The unit is now fully operational. Verify the proper operation of the link by following the steps in Section 3.4, page 12. No user adjustment or attention is required. See Section 3.5, page 13 for instructions on maintaining and cleaning the link. See Section 3.6, page 14 for information on troubleshooting.

### 3.3 Measuring RF Input Levels at the Transmitter

Excessive RF input to a fiber optic CATV transmitter **WILL** destroy the laser even if the unit is not powered. Lasers can be destroyed by being overdriven for as little as one nanosecond ( $10^{-9}$  seconds). Because they can be destroyed so quickly, it is essentially impossible to design a circuit or “fuse” that will blow before the laser is destroyed. Therefore it is imperative that the RF level be within acceptable limits **BEFORE** the cable is attached to the transmitter.

- 1) Using a spectrum analyzer, determine that the RF level input to the transmitter is within safety bounds.
- 2) The “RF In” LED on the unit gives a positive indication of the RF level. If the LED is yellow, the RF level is too low. Increase in 2 dB steps until the LED turns green. If the LED is red, the RF input level is too high. Disconnect the RF input immediately. Decrease RF levels by 6 dB and reconnect the RF input until the LED turns yellow or green. If it turns yellow, increase RF levels by 2 dB steps until the LED turns green.

Ideally, the RF level should be checked with an instrument such as a spectrum analyzer to verify that the levels are appropriate. If instrumentation is not available to actually measure the RF levels, Force recommends adding 40 dB of attenuation at the transmitter input; 40 dB of attenuation will adequately protect the unit from the highest RF levels that might be seen in a typical CATV installation. Do not attach the RF cable at this time, just verify the RF levels and/or add the appropriate attenuators at the transmitter input.

### 3.4 Performance Verification

No user maintenance is required. The Model 2809 **CATV**Linx<sup>®</sup> LDS CATV Receiver contains no user-serviceable parts and requires no routine service. Contact the factory if the unit requires warranty repair work. Once the units have been installed, verify that the picture quality is good. If the picture quality is not good, there are several likely causes:

- 1) The optical fiber may have large backreflections. Use an OTDR to examine the fiber run.
- 2) There may be non-APC optical connectors somewhere in the system. These cause unacceptable levels of backreflection.



- 3) The RF input spectrum may not be flat. It is possible to have a green RF Level LED even if the input spectrum has a large amount of tilt. All Force CATV products are designed to operate with a flat input spectrum.
- 4) There may be extraneous (i.e., non-video) signals in the input RF. Be sure to filter out all non-desirable signals.
- 5) The optical input power at the receiver may be too low. Assuming that the receiver shows a yellow light, the optical input level may be too low. See Figure 1.4 for the expected CNR versus the channel loading and received optical power.

### 3.5 Cleaning

If the units need to be cleaned, avoid the use of all solvents and use low-pressure clean air to remove loose dirt. Use low-pressure clean air to clear the connectors of any debris. Dirty or scratched connector end faces will greatly reduce the unit's performance. Foam-tipped swabs such as the 2.5mm Mini Foam Swab offered by Fiber Instrument Sales (P/N F1-0005) may be saturated with denatured alcohol\* and inserted into the optical port for cleaning. **DO NOT INSERT A DRY SWAB INTO THE OPTICAL PORT AS THIS MAY DAMAGE THE FIBER END FACE.** Many fiber optic installations experience degraded performance due to dirty optical connector end faces. The following procedure should be used to properly clean the optical connector end faces.

#### 3.5.1 Connector Cleaning

Required Cleaning Equipment:

- Kimwipes<sup>®</sup> or any lens-grade, lint-free tissue. The type sold for eyeglasses work quite well.
- Denatured Alcohol.

#### NOTE

Use only industrial grade 99% pure isopropyl alcohol. Commercially available isopropyl alcohol is for medicinal use and is diluted with water and a light mineral oil. Industrial grade isopropyl alcohol should be used exclusively.

- 30X Microscope.
- Canned Dry Air.

Directions for Cleaning:

- 1) Fold the tissue twice so it is four layers thick.
- 2) Saturate the tissue with alcohol.
- 3) First clean the sides of the connector ferrule. Place the connector ferrule in the tissue, and apply pressure to the sides of the ferrule. Rotate the ferrule several times to remove all contamination from the ferrule sides.
- 4) Now move to a clean part of the tissue. Be sure it is still saturated with alcohol, and it is still four layers thick. Put the tissue against the end of the connector ferrule. Put your fingernail against the tissue so that it is directly over the ferrule. Now scrape the end of the connector until it squeaks. It will sound like a crystal glass that has been rubbed when it is wet.
- 5) Use the microscope to verify the quality of the cleaning. If it isn't completely clean repeat the steps with a clean tissue.
- 6) Mate the connector immediately! Don't let the connector lie around and collect dust before mating.
- 7) Air can be used to remove lint or loose dust from the port of a transmitter or receiver to be mated with the connector. Never insert any liquid into the ports.

3.5.2 Connector Handling

- 1) **NEVER TOUCH THE FIBER END FACE OF THE CONNECTOR.**
- 2) Connectors not in use should be covered over the ferrule by a plastic dust cap. It is important to note that inside of the ferrule dust caps contains a sticky gelatinous residue that is the by-product of the making of the dust cap. This residue will remain on the ferrule end after the cap is removed. Therefore it is critical that the ferrule end be cleaned thoroughly BEFORE it is mated to the intended unit.

3.6 Troubleshooting

Common problems include lack of continuity in the optical fiber, lack of power (or reversed power), or improper input levels. The units are designed to work with a 75 Ohm system. Consult IOM2806 for additional troubleshooting of the transmitter. If problems persist, contact the factory.

Problem	Check	Comments
No optical power out of Tx.	Check Tx AC power connection.	If AC power is connected, check the primary AC power source to verify it is working. Contact Force, Inc. if no cause for this problem can be found.
No optical power at the 2809 Rx.	Check optical power output at the Tx.	If there is optical power at the Tx output, verify proper fiber is connected to the Rx. If the proper fiber is connected, ensure the integrity of the fiber.
Signal out of 2809 Rx is noisy.	Check optical power at the Rx.	See IOM2806 for the correct transmitter input levels required for proper operation. Be sure to ground the case of the Tx and Rx. Also, verify that all optical connectors are APC type.
No signal out of Rx.	Verify the input signal at the Tx.	See IOM2806 for the correct transmitter input levels required for proper operation.
Signal out of Rx is distorted.	Verify input signal at Tx.	The Tx input must be within the specs given in IOM2806. A larger signal will cause distortion.
	Verify fiber size.	Single-mode fiber must be used with this product.

3.7 Repair Service

For equipment repair or technical assistance, contact Customer Service (800) 732-5252 (USA) or (540) 382-0462. A Returned Material Authorization (RMA) number must be issued by Customer Service before the return of a failed unit. Units should be returned in their original shipping carton, if available. Always include a complete description of the failure or observed anomalies. All units are marked with model number and serial number. This identification sticker is placed on the rear panel (transmitter) or on the product label (receiver). The serial number is a date code used as a reference for warranty service.



# Index

## A

applications 5  
private network 5

## C

cleaning the optical connector 13  
cnr vs. rx optical input-channel loading diagram 3  
connections 9  
optical 8, 9, 11, 14  
power 8, 9  
RF 8, 9, 12

## D

diagrams, performance  
cnr vs. rx optical input-channel loading 3  
in-band frequency response 2

## F

FCC notice 1

## H

handling precautions 10  
handling the optical connector 14

## I

in-band frequency response diagram 2  
inspection 8  
installation 7–10  
general requirements 7  
items provided 7  
items required 7  
module placement 8  
outline drawing 8  
power-up 11  
RF input level measurement 12  
unit inspection 8

## L

laser safety precautions 9, 12  
LED  
optical level 8

## O

operating instructions 11–14  
performance verification 12  
RF input level measurement 12  
optical level LED 8  
ordering information 5

**P**

part numbers  
    transmitter 5  
power-up 11  
product drawing 8  
product overview 1  
product TB 1–6

**R**

receiver part numbers 7  
repair service 14  
RF input level measurement 12

**S**

safety precautions 9  
    laser safety 9, 12  
shipping precautions 10  
storage precautions 10

**T**

technical specifications 1–4  
    electrical 1  
    environmental 2  
    optical 1  
    physical 2  
    specification notes 2  
    video 1  
technical support. See troubleshooting  
transmitter part numbers 5, 7  
troubleshooting 14  
    repair service 14  
    technical support iii

**W**

warranty iii