

Model 2925

1RU DWDM

IOM2925
Revision 2.0, July 2004

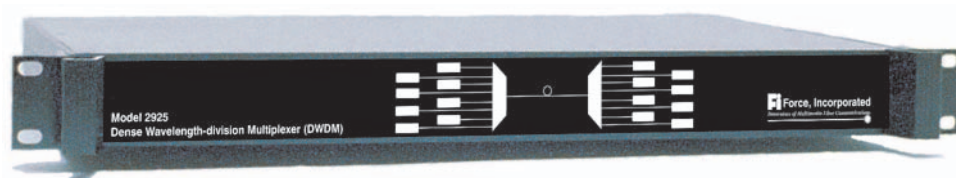

Instructions for Installation and Use
Read this manual before installing or using this product.
Observe all safety warnings and cautions.

Copyright © 2004 by Force, Incorporated. All rights reserved. Force, Incorporated reserves the right to make changes to the product described in this document in the interest of document improvement.





Preface

WARNING

The optical emissions from the optical connectors and the optical fiber are laser-based and may present eye hazards. Follow all safety precautions.

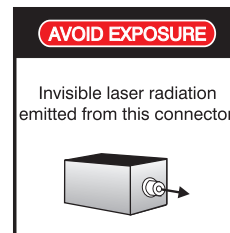
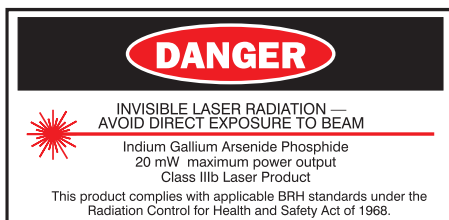

About this Manual

This manual explains how to configure and install the Model 2925 1RU DWDM. It is intended for engineers and technicians who will install the Model 2925 units. While this guide provides basic information on how to configure and install the units, it assumes that you as the user are familiar with:

- the installation and manipulation of electronic and fiber optic transport equipment
- the installation and manipulation of dense wavelength-division multiplexers

This manual is divided into the following sections:

- Section 1, page 1: Describes the Model 2925, lists technical specifications, performance graphs, system applications, and ordering information.
- Section 2, page 5: Describes the installation of the Model 2925 and its connections to companion optical transport equipment.
- Section 3, page 9: Describes the operation of the Model 2925, troubleshooting, and user maintenance.

A quick-reference index completes the user manual.



Related Documentation

- AN136: DWDM/CWDM and ITU Channels
- *Fiber Optic Reference Guide, 3rd Edition*. by David R. Goff (Focal Press 2002): General theory and operation of fiber optic units.
- Web Site: Our web site, <http://www.forceinc.com> may be used to download the latest versions of this manual.

Technical Support

If you encounter any kind of problem after reading this manual, contact your local distributor or a Force, Inc. Applications Engineer. To reach technical support:

On the Web:	http://www.forceinc.com
By Phone (Monday through Friday 8:00 am to 5:00 pm EST):	USA (800) 732-5252 TEL (540) 382-0462
By Fax:	(540) 381-0392
By Email:	csr-sales@forceinc.com

Warranty

Force, Incorporated standard products are warranted to be free from defects in materials and workmanship, meeting or exceeding factory specified performance standards for a period of three (3) years from date of purchase.

Force Obligations

Force will, at its discretion and expense, repair any defect in materials or workmanship or replace the product with a new product. Force will, upon receipt of the return, evaluate the product and communicate to the customer the nature of the problem, and determine if the claim falls under warranty coverage.

If during the warranty period, Force is unable to repair the product to the original warranted state within a reasonable time, or if subcomponents of the unit have been obsoleted or discontinued, then Force has the option to provide an equivalent unit.

Exclusions

This warranty does not extend to any product that has been damaged due to acts of God, accident, misuse, abuse, neglect, improper system design or application, improper installation, improper operation or maintenance, or connection to an improper voltage supply.

The Force warranty does not cover fuses, batteries, and lamps. Modifications or alterations of Force products (including but not limited to installation of non-Force equipment or computer programs), except as authorized by Force, will void this warranty. Removal or breaking of the seals on the product will also void the warranty. In addition, cost of repair by unauthorized persons within the warranty period of the product will not be covered by Force, Incorporated. Such repairs will void the warranty.

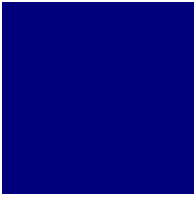

Force, Incorporated makes no other representation or warranty of any other kind, express or implied, with respect to the goods, whether as to merchantability, fitness for a particular purpose, or any other matter. Force, Incorporated's liability shall not include liability for any special, indirect or consequential damages, or for any damages arising from or attributable to loss of use, loss of data, loss of goodwill, or loss of anticipated or actual revenue or profit, or failure to realize expected savings, even if Force, Incorporated has been advised of the possibility of such damages. This warranty constitutes Force, Incorporated's entire liability and the customer's sole remedy for defects in material and workmanship.



Contents

Preface	ii
Section 1 Product Technical Bulletin	1
1.1 Product Overview.....	1
1.2 Optical Specifications.....	1
1.3 Environmental and Physical Specifications.....	2
1.4 Specification Notes	2
1.5 Applications.....	2
Figure 1.1 CATV Network in a Redundant Path Configuration with Model 2925 1RU DWDM	2
Figure 1.2 L-Band Teleport Transport using a DWDM	4
1.6 Part Numbers	4
Section 2 Installation Instructions	5
2.1 General Installation Requirements.....	5
2.2 Items Provided.....	5
2.3 Items Required	5
2.4 Inspection.....	5
2.5 Equipment Rack Configuration	6
2.6 Connections	6
2.7 Rear Panel Description.....	6
Figure 2.1 Model 2925 1RU DWDM Rear Panel.....	6
2.8 Safety Precautions	6
2.8.1 Laser Safety Procedures	7
2.9 Shipping and Handling Precautions.....	7
2.10 Storing the Unit.....	7

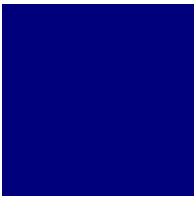

- Section 3 Operating Instructions 9**
 - 3.1 Connections and Power-up..... 9
 - 3.2 Performance Verification..... 9
 - 3.3 Cleaning 9
 - 3.3.1 Optical Connector Cleaning Equipment 10
 - 3.3.2 Directions for Optical Connector Cleaning 10
 - 3.3.3 Connector Handling..... 10
 - 3.4 Troubleshooting..... 11
 - 3.5 Repair Service 11
- Index 13**

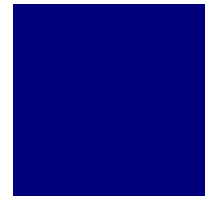

Section 1 Product Technical Bulletin

1.1 Product Overview

The Model 2925 1RU DWDM is an all-fiber, bidirectional multiplexer/demultiplexer. The dense wavelength-division multiplexer/demultiplexer allows four, eight, 16, or 32 channels to be stacked in the 1550 nm region of optical fiber. The Model 2925 features low insertion loss and a low polarization-dependent loss. The units operate using single-mode fiber, and may be configured for unidirectional or bidirectional four, eight, 16, or 32 channel transmission. The Model 2925 implements high channel-to-channel isolation to ensure that minimal interference occurs between channels in a bidirectional configuration. DWDM technology increases the capacity of the embedded fibers, allowing multiple video, audio, and data channels to be transmitted over one fiber, while maintaining system performance and enhancing transport systems. The Model 2925 is an excellent choice for addressing the increased need for efficient and capable optical transmission.

1.2 Optical Specifications

		Min.	Typ.	Max.	Units	Notes
Optical Power				250	mW	See Section 1.4
Center Wavelength	4 or 8 Ch.	ITU Channel \pm 0.1			nm	
	16 or 32 Ch.	ITU Channel \pm 0.06			nm	
0.5 dB Passband	4 or 8 Ch.		0.75		nm	
	16 Ch.		0.38		nm	
	32 Ch.		0.35		nm	
Insertion Loss	4 Ch.		2.0	2.4	dB	1
	8 Ch.		3.6	4.5	dB	1
	16 Ch.		5.2	5.8	dB	1
	32 Ch.		7.5	8.5	dB	1
Ch. Uniformity	4 Ch.			1.2	dB	2
	8, 16 or 32 Ch.			1.5	dB	2
Demux Isolation of Adjacent Ch.			25		dB	
Demux Isolation of Non-adjacent Ch.			40		dB	
Directivity (4, 8, or 16 Ch.)		55			dB	
Directivity (32 Ch)		50			dB	
Polarization Dependent Loss	4 or 8 Ch.			0.1	dB	
	16 Ch.			0.15	dB	

		Min.	Typ.	Max.	Units	Notes See Section 1.4
PMD	32 Ch.			0.2	dB	
	4 or 8 Ch.			0.1	ps	
	16 or 32 Ch.			0.2	ps	
Return Loss		45			dB	
Thermal Stability	4 Ch.			0.006	dB/°C	
	8 Ch.			0.007	dB/°C	
	16 Ch.			0.008	dB/°C	
	32 Ch.			0.01	dB/°C	
Thermal Wavelength Drift	4 or 8 Ch.			0.002	nm/°C	
	16 or 32 Ch.			0.001	nm/°C	

1.3 Environmental and Physical Specifications

	Min.	Typ.	Max.	Units	Notes See Section 1.4
Operating Temperature Range	0		+65	°C	
Storage Temperature Range	-40		+85	°C	
Humidity	5		90	%	3
Weight		5.5		lbs.	
		2.4		kg	
Physical Dimensions	19.0 x 1.75 x 11.8			in.	4
	483 x 45 x 300			mm	4

1.4 Specification Notes

- 1) Insertion loss figures are for both the mux and demux.
- 2) Channel uniformity specification is given at the center wavelength.
- 3) Humidity is RH non-condensing.
- 4) Dimensions include mounting flanges.

1.5 Applications

Figure 1.1 illustrates the Model 2925 in a CATV network using a redundant fiber path configuration via the Model 5615 Optical A/B Switch. In this application, eight CATV transmitters using DWDM wavelengths connect to the Model 2925 1RU DWDM mux, which feeds a Model 1188 1 x 2 optical splitter. The two outputs of the splitter feed two fibers. Normally each fiber will take a different route to improve reliability. The Model 5615 feeds the DWDM demux, outputting the original CATV signals.

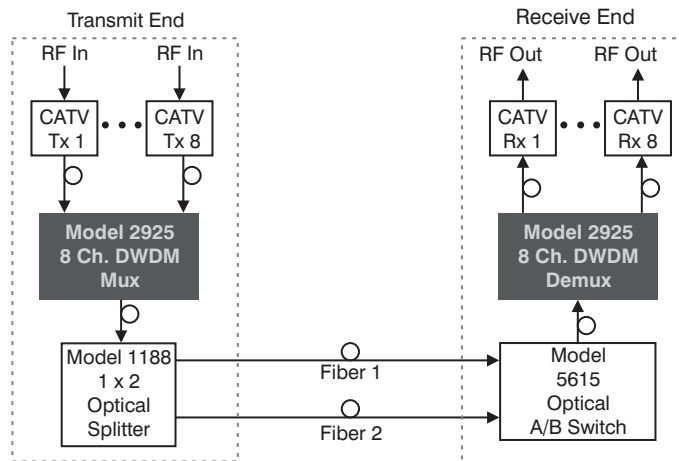

Figure 1.1 CATV Network in a Redundant Path Configuration with Model 2925 1RU DWDM



Bidirectional optical systems usually require a demultiplexer at both ends. EDFAs are generally not practical in a bidirectional system. Consult the factory with specific questions. The 6901 and 6902 EDFAs can only be used with red band DWDM systems, See Table 1, page 3. This limits it to a maximum of 16 channels. The 6903 EDFA can be used with red band and/or blue band DWDM systems, See Table 1, page 3. This allows the EDFA to handle a maximum of 32 channels.

Table 1: ITU Frequencies and Wavelengths

ITU Channel	ITU Grid Frequencies and Wavelengths		Speed of Light = 299792.5 km/s					
	Frequency (THz)	Wavelength (nm)	Blue Band	Red Band	4-Ch. Plan	8-Ch. Plan	16-Ch. Plan	32-Ch. Plan
61	196.1	1528.77	X					
60	196.0	1529.55	X					
59	195.9	1530.33	X					
58	195.8	1531.12	X					
57	195.7	1531.90	X					
56	195.6	1532.68	X					X
55	195.5	1533.47	X					X
54	195.4	1534.25	X					X
53	195.3	1535.04	X					X
52	195.3	1535.82	X					X
51	195.1	1536.61	X					X
50	195.0	1537.40	X					X
49	194.9	1538.19	X					X
48	194.8	1538.98	X					X
47	194.7	1539.77	X					X
46	194.6	1540.56	X					X
45	194.5	1541.35	X					X
44	194.4	1542.14	X					X
43	194.3	1542.94	X					X
42	194.2	1543.73	X					X
41	194.1	1544.53	X					X
40	194.0	1545.32	X					
39	193.9	1546.12		X				
38	193.8	1546.92		X				
37	193.7	1547.72		X			X	
36	193.6	1548.51		X			X	X
35	193.5	1549.32		X			X	X
34	193.4	1550.12		X			X	X
33	193.3	1550.92		X			X	X
32	193.2	1551.72		X			X	X
31	193.1	1552.52		X			X	X
30	193.0	1553.33		X			X	X
29	192.9	1554.13		X		X	X	X
28	192.8	1554.94		X		X	X	X
27	192.7	1555.75		X		X	X	X
26	192.6	1556.56		X		X	X	X
25	192.5	1557.36		X	X	X	X	X
24	192.4	1558.17		X	X	X	X	X
23	192.3	1558.98		X	X	X	X	X
22	192.2	1559.79		X	X	X	X	X
21	192.1	1560.61		X				X
20	192.0	1561.42		X				
19	191.9	1562.23		X				
18	191.8	1563.05		X				
17	191.7	1563.86		X				

Figure 1.2 illustrates a high density Teleport application, using the Model 2925 to increase the number of channels per fiber. In this application, the transmitted L-Band signals from the Model 3000 go through an EDFA (Model 6901), to increase the transmission distance significantly.

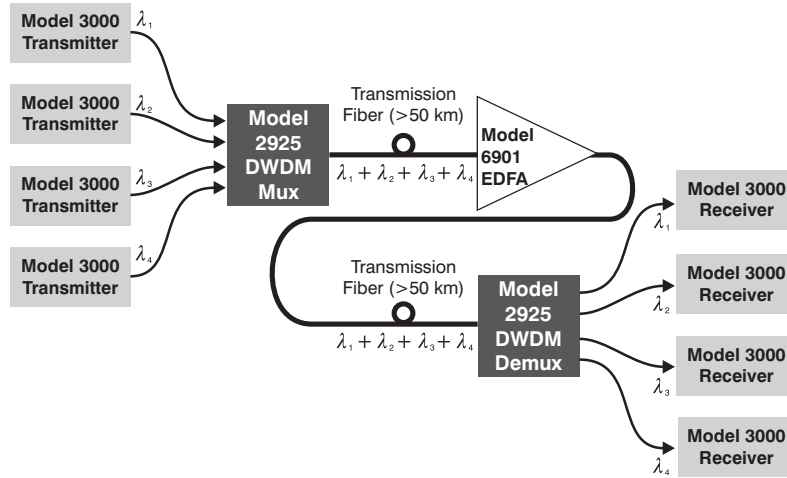

Figure 1.2 L-Band Teleport Transport using a DWDM

1.6 Part Numbers

Part Number	Description
2925WM-SDSP/4	DWDM Mux, 4-Ch., 100 GHz ITU Grid, 1RU Rack-mount, SC/APC Connectors
2925WM-SDSP/8	DWDM Mux, 8-Ch., 100 GHz ITU Grid, 1RU Rack-mount, SC/APC Connectors
2925WM-SDSP/16	DWDM Mux, 16-Ch., 100 GHz ITU Grid, 1RU Rack-mount, SC/APC Connectors
2925WM-SDSP/32	DWDM Mux, 32-Ch., 100 GHz ITU Grid, 1RU Rack-mount, SC/APC Connectors
2925WD-SDSP/4	DWDM Demux, 4-Ch., 100 GHz ITU Grid, 1RU Rack-mount, SC/APC Connectors
2925WD-SDSP/8	DWDM Demux, 8-Ch., 100 GHz ITU Grid, 1RU Rack-mount, SC/APC Connectors
2925WD-SDSP/16	DWDM Demux, 16-Ch., 100 GHz ITU Grid, 1RU Rack-mount, SC/APC Connectors
2925WD-SDSP/32	DWDM Demux, 32-Ch., 100 GHz ITU Grid, 1RU Rack-mount, SC/APC Connectors
8000-0241-03	Optical Jumper, SM, 1 Meter, SC/APC Connectors
8000-0241-04	Optical Jumper, SM, 3 Meter, SC/APC Connectors



Section 2 Installation Instructions

2.1 General Installation Requirements

The installation of these units is very simple. There are no special unpacking instructions, except that care should be taken to handle units gently. The unit requires no assembly and only threshold adjustments are needed. Follow the instructions below to properly install the units.

2.2 Items Provided

The following is a list of items provided with each Model 2925 1RU DWDM:

Qty.	Mfr.	P/N	Description
AR	Force, Inc.	6925WM-SDSP/X	DWDM Mux, 1RU, SC/APC Connector, 4, 8, or 16 channels (X specifies the channel count.).
AR	Force, Inc.	6925WD-SDSP/X	DWDM Demux, 1RU, SC/APC Connector, 4, 8, or 16 channels (X specifies the channel count.).
AR	Force, Inc.	8000-0241-XX	Optical Jumpers as required. See Section 1.6, page 4 for part numbers
1 per connector	AR	Any	Active Device Receptacle Caps

2.3 Items Required

Qty.	Mfr.	P/N	Description
AR	Any	Any	Standard IEC 19" Wide Relay Rack
4 sets per unit	Any	Any	Bolts, Washers, and Nuts Required to Install Unit in the Relay Rack
AR	Any	Any	Optical Transmission Terminals
AR	Any	Any	9/125 μm Single-mode Fiber

2.4 Inspection

Remove the unit from its shipping container. Any in-shipment damage that may have occurred should be visually apparent. Look for bent or damaged connectors or mounting brackets. Claims for damage incurred in shipment should be made directly to the transportation company in accordance with their instructions. Save the shipping cartons until installation and performance verification are completed.

2.5 Equipment Rack Configuration

Carefully unpack the unit, and install it in your earth grounded equipment rack. Make sure to load the heaviest equipment near the bottom of the rack and the lightest equipment at the top of the rack. The surface of the equipment rack that mates to the chassis mounting ears should be conductive. The unit should be located in an area that provides adequate lighting and is relatively free from dust. The units are each housed in a single 19" EIA standard 1RU (1.75 inch) rack-mount chassis.

2.6 Connections

Connector Name	Connector Type	Mux Connector Function	Demux Connector Function
Common	SC/APC	Transmission Fiber Optical Output	Transmission Fiber Optical Input
22-25* (4 Ch.)	SC/APC	ITU Channel Connections	ITU Channel Connections
22-29* (8 Ch.)	SC/APC	ITU Channel Connections	ITU Channel Connections
22-37 (16 Ch.)	SC/APC	ITU Channel Connections	ITU Channel Connections
21-36 and 41-56 (32 Ch.)	SC/APC	ITU Channel Connections	ITU Channel Connections

Only APC type optical connectors should be connected to the optical ports. Never connect a PC or UPC type connector to these units. Permanent damage to the optical ports can result.
 * The unit ships with the required optical jumpers. May also be ordered separately. See Section 1.6, page 4 for part numbers.

2.7 Rear Panel Description

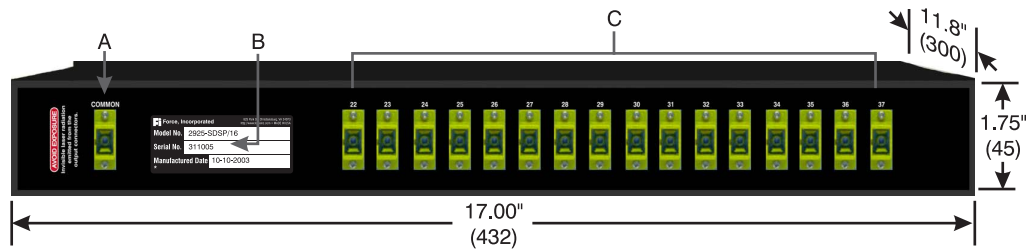

- A. Common (SC/APC Connector): On the multiplexer unit, this connector provides the transmission fiber optical port. On the demultiplexer unit, this connector provides the transmission fiber optical port.
- B. Product Serial Number: The product serial number is a date code that specifies the activation date of the product warranty.
- C. ITU Channels (SC/APC Connector): On the multiplexer unit, these connectors provide the

ITU channel optical ports. On the demultiplexer unit, these connectors provide the ITU channel optical ports. See Table 1 on page 3.

WARNING

OPTICAL LASER RADIATION IS PRESENT AT THE OPTICAL OUTPUT CONNECTORS. AVOID DIRECT EYE EXPOSURE TO THE INVISIBLE BEAM.

Figure 2.1 Model 2925 1RU DWDM Rear Panel
 (Dimensions in parenthesis are in millimeters)

2.8 Safety Precautions

The optical emission from the units are laser-based Class IIIb, and may present eye hazards if improperly used. **NEVER USE ANY KIND OF OPTICAL INSTRUMENT TO VIEW THE OPTICAL OUTPUT OF THE UNIT.** As always, be careful when working with optical fibers. Fibers can cause painful injury if they penetrate the skin.



2.8.1 Laser Safety Procedures

- 1) **ALWAYS** read the product data sheet and the laser safety label before powering the product. Note the operating wavelength, optical output power, and safety classification.
- 2) If safety goggles or other eye protection are used, be certain that the protection is effective at the wavelength(s) emitted by the device under test **BEFORE** applying power.
- 3) **ALWAYS** connect a fiber to the output of the device **BEFORE** power is applied. Power should never be applied without an attached fiber output. If the device has a connector output, a connector should be attached that is connected to a fiber. This ensures that all light is confined within the fiber waveguide, virtually eliminating all potential hazard.
- 4) **NEVER** look in the end of a fiber to see if light is coming out. **NEVER!** Most fiber optic laser wavelengths (1310 nm and 1550 nm) are totally invisible to the unaided eye and will cause permanent damage. Shorter wavelength lasers (e.g. 780 nm) are visible and are very damaging. Always use instruments, such as an optical power meter, to verify light output.
- 5) **NEVER NEVER NEVER** look into the end of a fiber on a powered device with **ANY** sort of magnifying device. This includes microscopes, eye loupes, and magnifying glasses. This **WILL** cause a permanent, irreversible burn on your retina. Always double check that power is disconnected before using such devices. If possible, completely disconnect the unit from any power source.
- 6) If you have questions about laser safety procedures, please call Force, Incorporated for assistance before powering your product. A Sales Engineer or Applications Engineer may be reached at (540) 382-0462.
- 7) Laser safety classes for the Model 2925 are as follows:

Class	Wavelength Range	Optical Power Accession Limits
IIIb	180 nm to 400 nm	Varies with λ and exposure time. 0.5 Watt
	400 nm to 10^6 nm	

2.9 Shipping and Handling Precautions

The units are, in general, very rugged and can withstand the stresses of most shipping and handling circumstances. However, the following precautions should be taken:

- 1) When the units are shipped they should be wrapped in a protective material, such as bubble wrap, to protect against excessive jarring and to prevent damage to the external finish of the units. Always use packing material to separate multiple units that are packaged together.
- 2) Care should be taken not to drop or strike the units in any way, especially around the optical connectors.
- 3) The units should never be immersed in liquid.

2.10 Storing the Unit

If a unit is to be out of use for an extended period of time, the following steps should be taken to ensure the preservation of the unit:

- 1) The storage temperature range is -40°C to +85°C.
- 2) A low humidity environment is preferable for long term storage.
- 3) All connectors should be covered with active device receptacle caps.



Notes:



Section 3 Operating Instructions

3.1 Connections and Power-up

- 1) Be sure all fiber optic transmitters to be connected to the Model 2925 are OFF before proceeding.
- 2) Install the Model 2925 as described in Section 2, page 5.
- 3) Clean all optical connectors. See 3.3 for cleaning instructions.
- 4) At the first end of the fiber, connect the optical DWDM transmitter outputs to the appropriate ITU optical ports on the multiplexer using the optical jumpers provided with the Model 2925. (Note that if this is a bidirectional system, then Model 2925 demultiplexers may be used on both ends of the fiber and transmitters and receivers may connect to the same Model 2925.)
- 5) Connect the “Transmission fiber optic port” to the transmission fiber. Be sure that the fiber has continuity and that the optical loss is close to the expected value.
- 6) At the second end of the fiber, connect the transmission fiber to the “Transmission fiber optic port” on the Model 2925 multiplexer or demultiplexer. Connect the optical receivers to the appropriate ITU optical ports on the demultiplexer using the optical jumpers provided with the Model 2925. (Note that if this is a bidirectional system, the Model 2925 demultiplexers may be used on both ends of the fiber and transmitters and receivers may connect to the same Model 2925.)
- 7) Apply power to the optical transmitters and receivers as detailed in the user manuals for the companion equipment. Assuming that the transmitters and receivers are operating properly, the system is now fully operational. No additional user adjustment or attention is required. See Section 3.3.2, page 10 for instructions on cleaning and maintaining the unit.

3.2 Performance Verification

No user maintenance is required. The Model 2925 contains no user serviceable parts and requires no routine service. Contact the factory if the unit requires warranty repair work.

3.3 Cleaning

If the units need to be cleaned, avoid the use of all solvents and use low-pressure clean air to remove loose dirt. Use low-pressure clean air to clear the connectors of any debris. Dirty or scratched connector end faces will greatly reduce the unit's

performance. Foam-tipped swabs such as the 2.5mm Mini Foam Swab offered by Fiber Instrument Sales (P/N F1-0005) may be saturated with denatured alcohol and inserted into the optical port for cleaning. **DO NOT INSERT A DRY SWAB INTO THE OPTICAL PORT AS THIS MAY DAMAGE THE FIBER END FACE.** Many fiber optic installations experience degraded performance due to dirty optical connector end faces. The following procedure should be used to properly clean the optical connector end faces.

3.3.1 Optical Connector Cleaning Equipment

- Kimwipes® or any lens-grade, lint-free tissue. The type sold for eyeglasses work quite well.
- Denatured Alcohol.

NOTE

Use only industrial grade 99% pure isopropyl alcohol. Commercially available isopropyl alcohol is for medicinal use and is diluted with water and a light mineral oil. Industrial grade isopropyl alcohol should be used exclusively.

- 30X Microscope.
- Canned Dry Air.

3.3.2 Directions for Optical Connector Cleaning

- 1) Fold the tissue twice so it is four layers thick.
- 2) Saturate the tissue with alcohol.
- 3) First clean the sides of the connector ferrule. Place the connector ferrule in the tissue, and apply pressure to the sides of the ferrule. Rotate the ferrule several times to remove all contamination from the ferrule sides.
- 4) Now move to a clean part of the tissue. Be sure it is still saturated with alcohol, and it is still four layers thick. Put the tissue against the end of the connector ferrule. Put your fingernail against the tissue so that it is directly over the ferrule. Now scrape the end of the connector until it squeaks. It will sound like a crystal glass that has been rubbed when it is wet.
- 5) Use the microscope to verify the quality of the cleaning. If it isn't completely clean repeat the steps with a clean tissue.
- 6) Mate the connector immediately! Don't let the connector lie around and collect dust before mating.
- 7) Air can be used to remove lint or loose dust from the port of a transmitter or receiver to be mated with the connector. Never insert any liquid into the ports.

3.3.3 Connector Handling

- 1) **NEVER TOUCH THE FIBER END FACE OF THE CONNECTOR.**
- 2) Connectors not in use should be covered over the ferrule by a plastic dust cap. It is important to note that inside of the ferrule dust caps contains a sticky gelatinous residue that is the by-product of the making of the dust cap. This residue will remain on the ferrule end after the cap is removed. Therefore it is



critical that the ferrule end be cleaned thoroughly BEFORE it is mated to the intended unit.

3.4 Troubleshooting

The Model 2925 1RU DWDM is a passive device and rarely represents a point of failure for a DWDM system. Be sure to maintain clean optical connections at all times. More common problems involve the optical transport terminals, including using an optical transmitter as a receiver and vice versa, lack of continuity in the optical fiber, lack of power (or reversed power) at the transmitter or receiver ends, or improper transmitter or receiver input levels. If problems persist consult the Force, Inc. reference materials listed below, or contact the factory.

3.5 Repair Service

For equipment repair or technical assistance, contact Customer Service (800) 732-5252 (USA) or (540) 382-0462. A Returned Material Authorization (RMA) number must be issued by Customer Service before the return of a failed unit. Units should be returned in their original shipping carton, if available. Always include a complete description of the failure or observed anomalies. All units are marked with model number and serial number. This identification sticker is placed on the rear panel or on the product label. The serial number is a date code used as a reference for warranty service.



Notes:

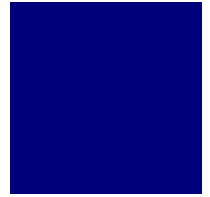

Index

A

applications

- 1-band teleport using DWDM 4
- redundant path configuration with dwdm 2

C

- cleaning the optical connector 10
- cleaning the unit 9

H

- handling precautions 7
- handling the optical connector 10

I

- installation 5–7
 - connections 6, 9
 - general requirements 5
 - inspection 5
 - items provided 5
 - items required 5

- performance verification 9

- power-up 9

- rack configuration 6

- rear panel description 6

- installation instructions 5

L

- laser safety precautions ii, 6, 7

O

- operating instructions 9–12

P

- part numbers 4

- performance verification 9

- product overview 1

- product TB 1–4

R

- rear panel description 6

- repair service 11

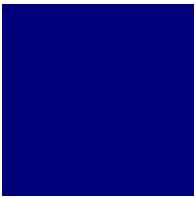

S

- safety precautions 6
 - laser safety ii, 6, 7
- shipping precautions 7
- storage precautions 7

T

- technical specifications
 - environmental 2
 - notes 2
 - optical 1
 - physical 2
- technical support. See troubleshooting
- troubleshooting 11
 - repair services 11
 - technical support iii

W

- warranty iii